

Der Schnitt enthält keine Nahtzugabe.
Seam allowance not included.

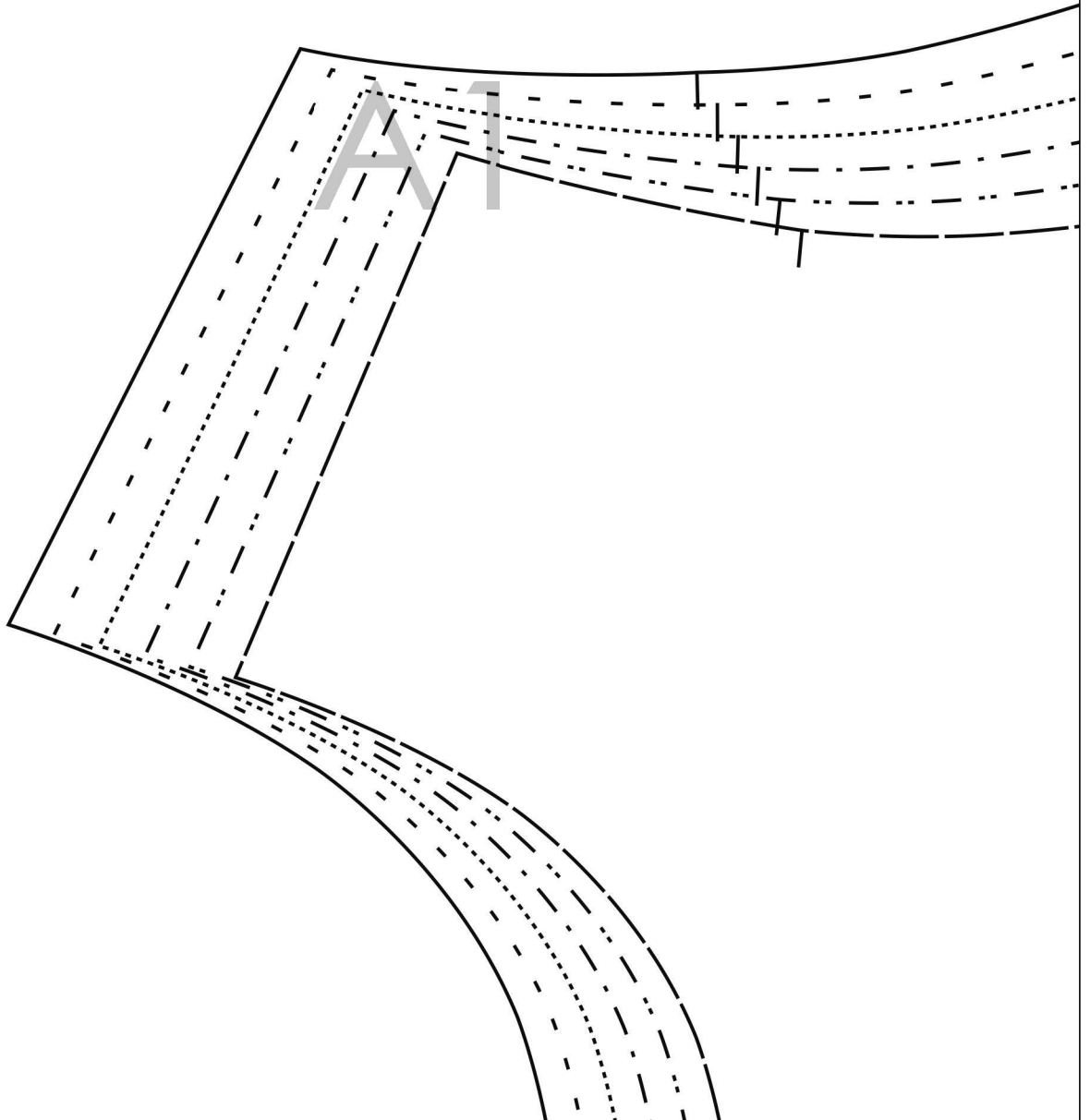

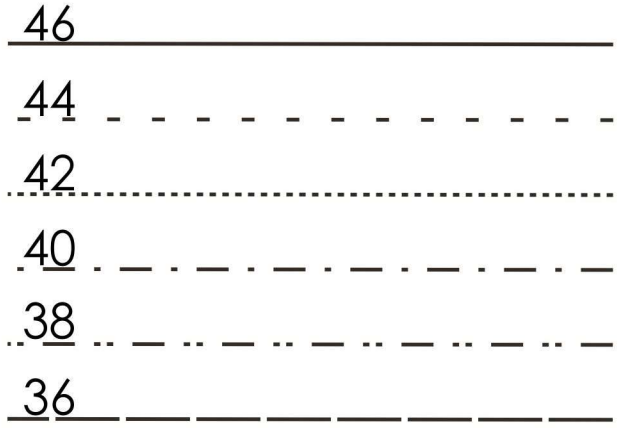
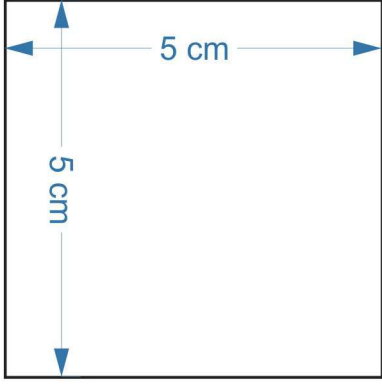
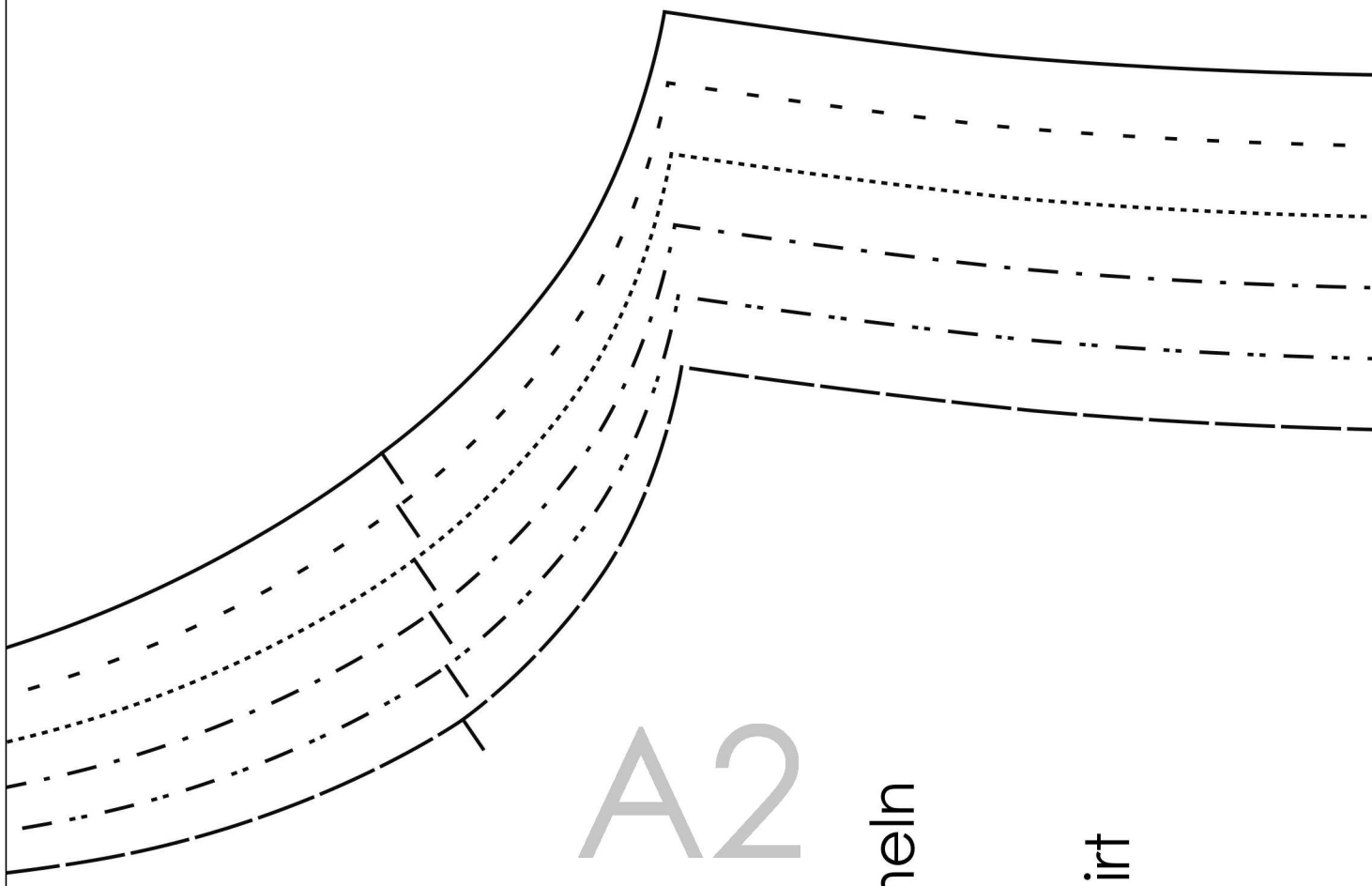

A2

Rollkragen Shirt mit Puffärmeln
Vorderteil 1 x im Bruch

Puff sleeves turtleneck shirt
Front 1 x on fold



A3

The image shows a standard A3 paper template. It features a series of horizontal lines for writing, including a solid top line, a dashed line, a dotted line, a dash-dot line, and a dashed bottom line. Vertical tick marks are present on the left side of the lines. The text 'A3' is centered in the lower half of the page.

A4

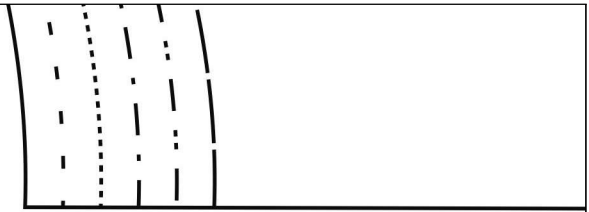

Stoffbruch / Fold

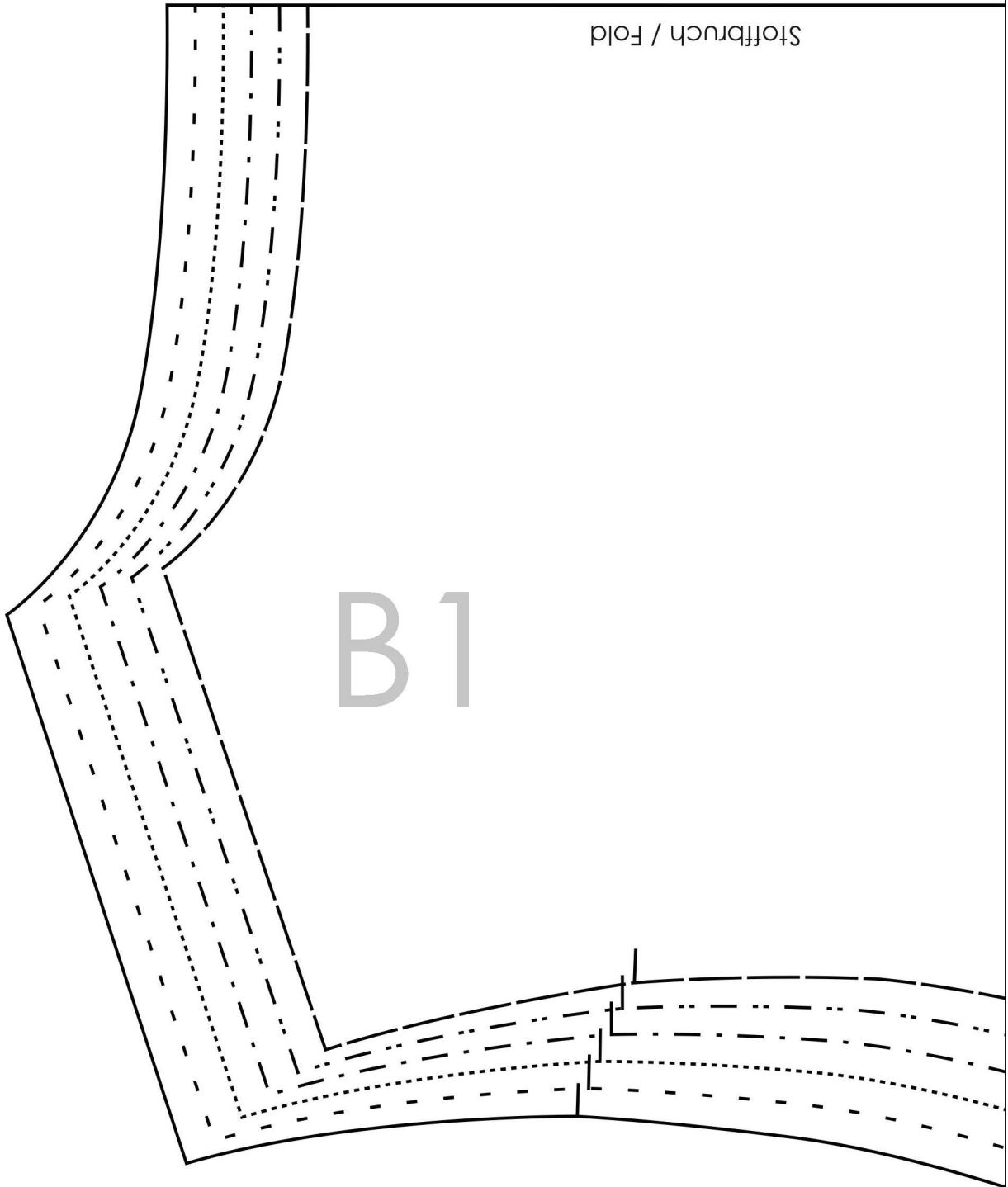

B1



Rollkraagen: 1 x

Stoffbruch / Fold

Rollkragen Shirt mit Puffärmeln
Rückenteil 1 x im Bruch

Puff sleeves turtleneck shirt
back 1 x on fold

BZ

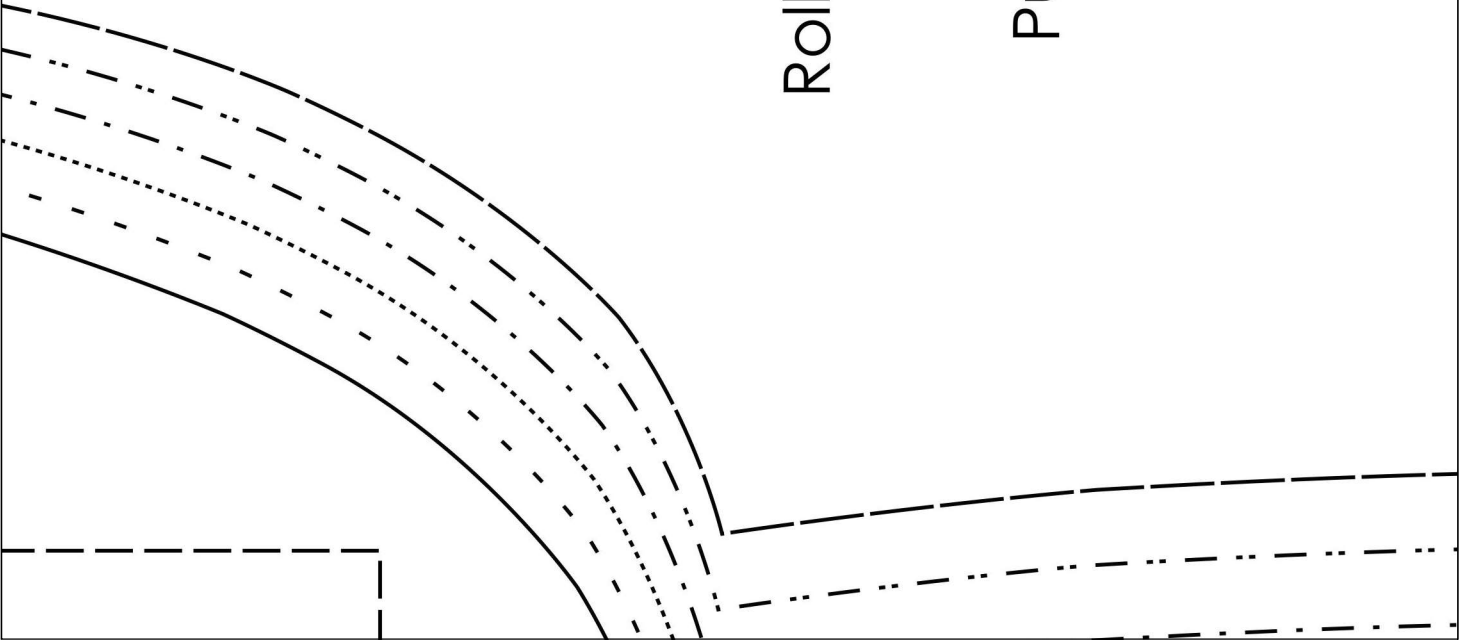

B3

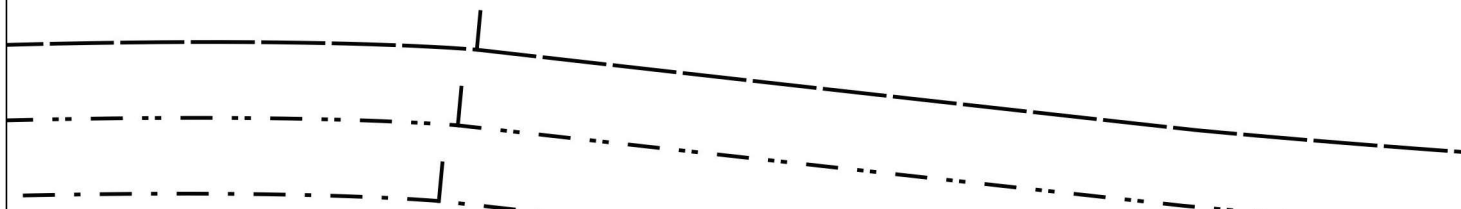

Hemm
fabrics

Hemmers Itex
fabrics for your creativity

B4



41,5 / 42,5 / 43 / 44 / 45 / 55 cm
0,7cm Nahtzugabe entha

Turtleneck 1 x
41,5 / 42,5 / 43 / 44 / 45 / 55 cm
Incl. seam allowance 0,7c

C1

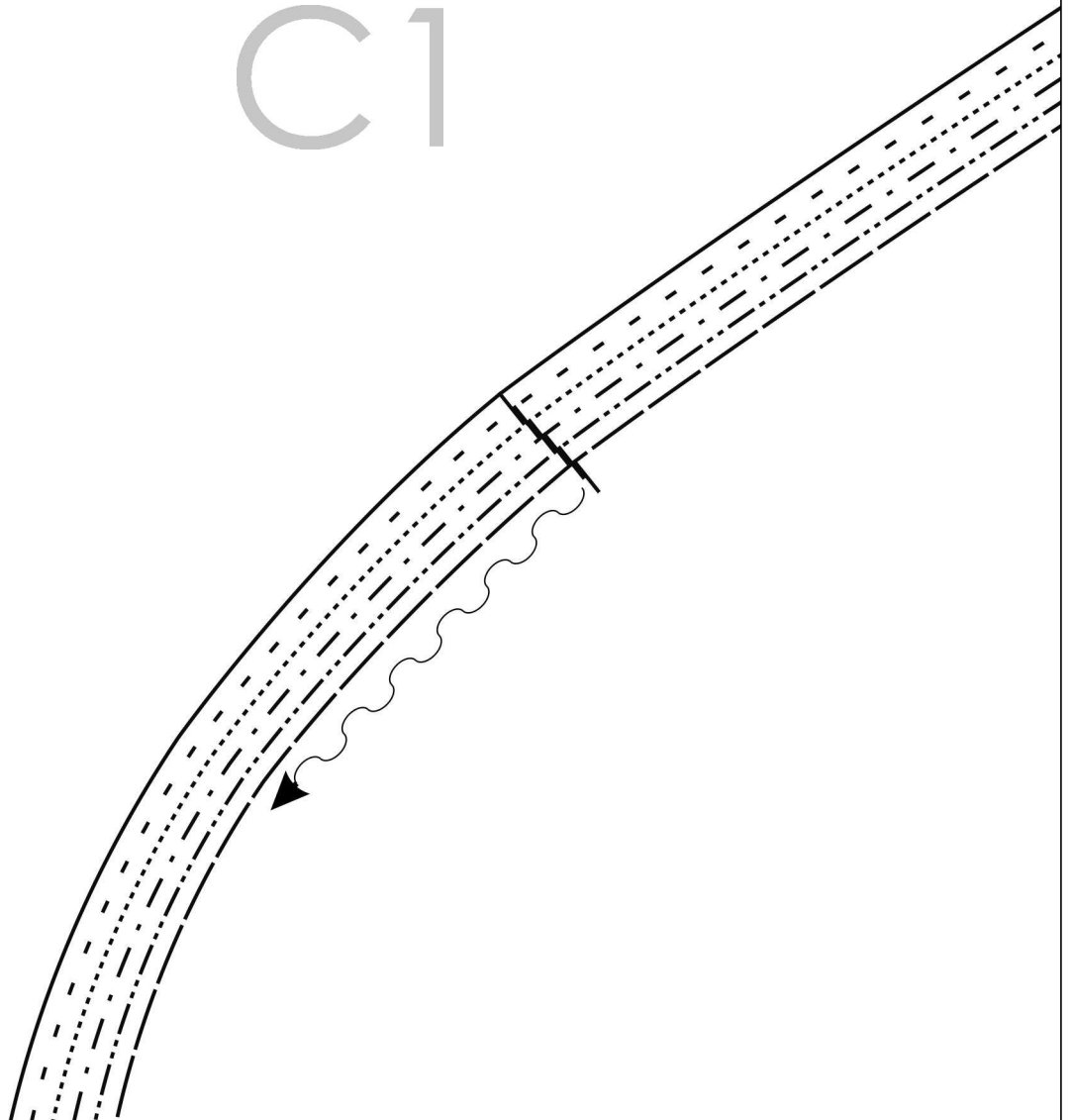

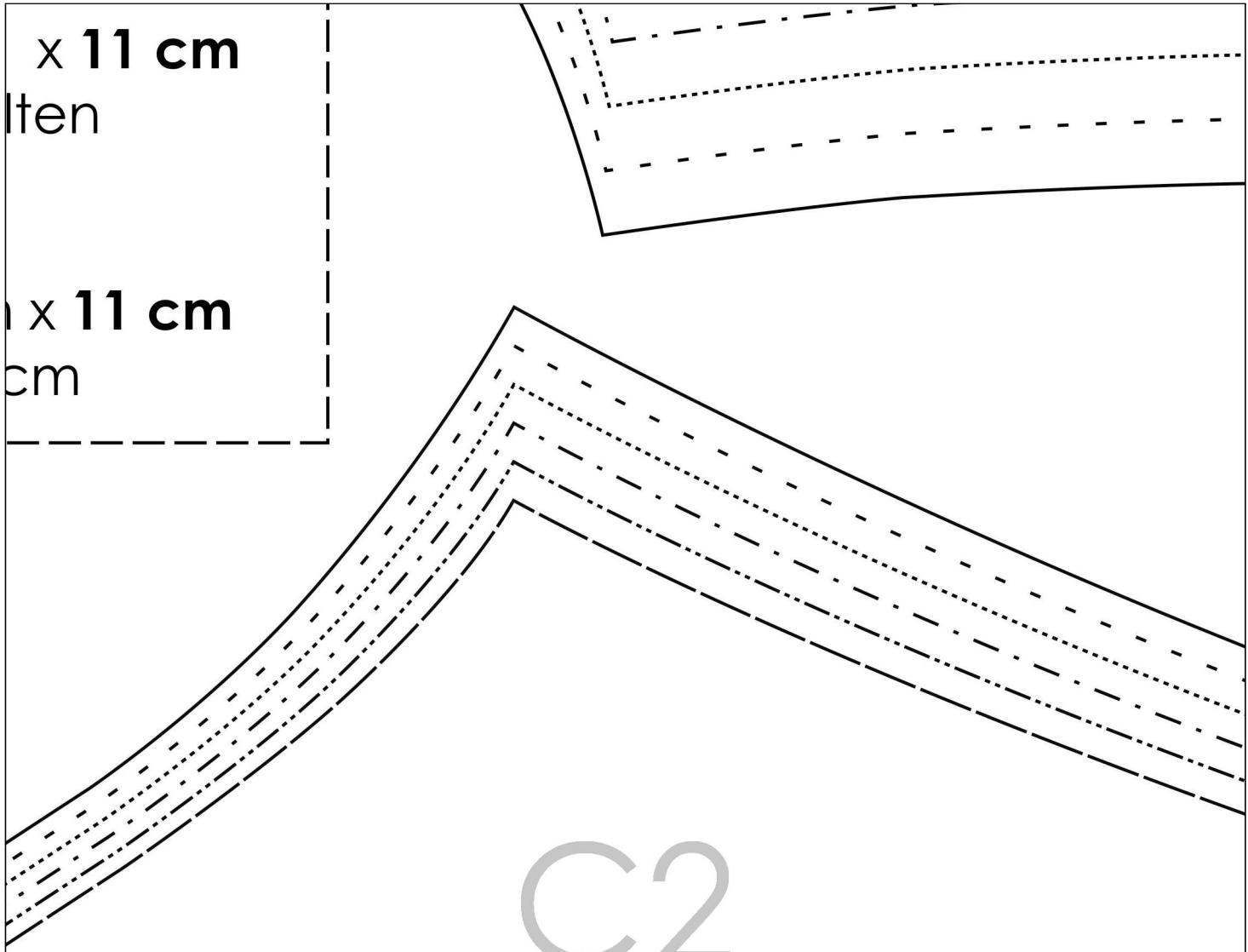

C2

Puffärmeln

x

neck shirt

x

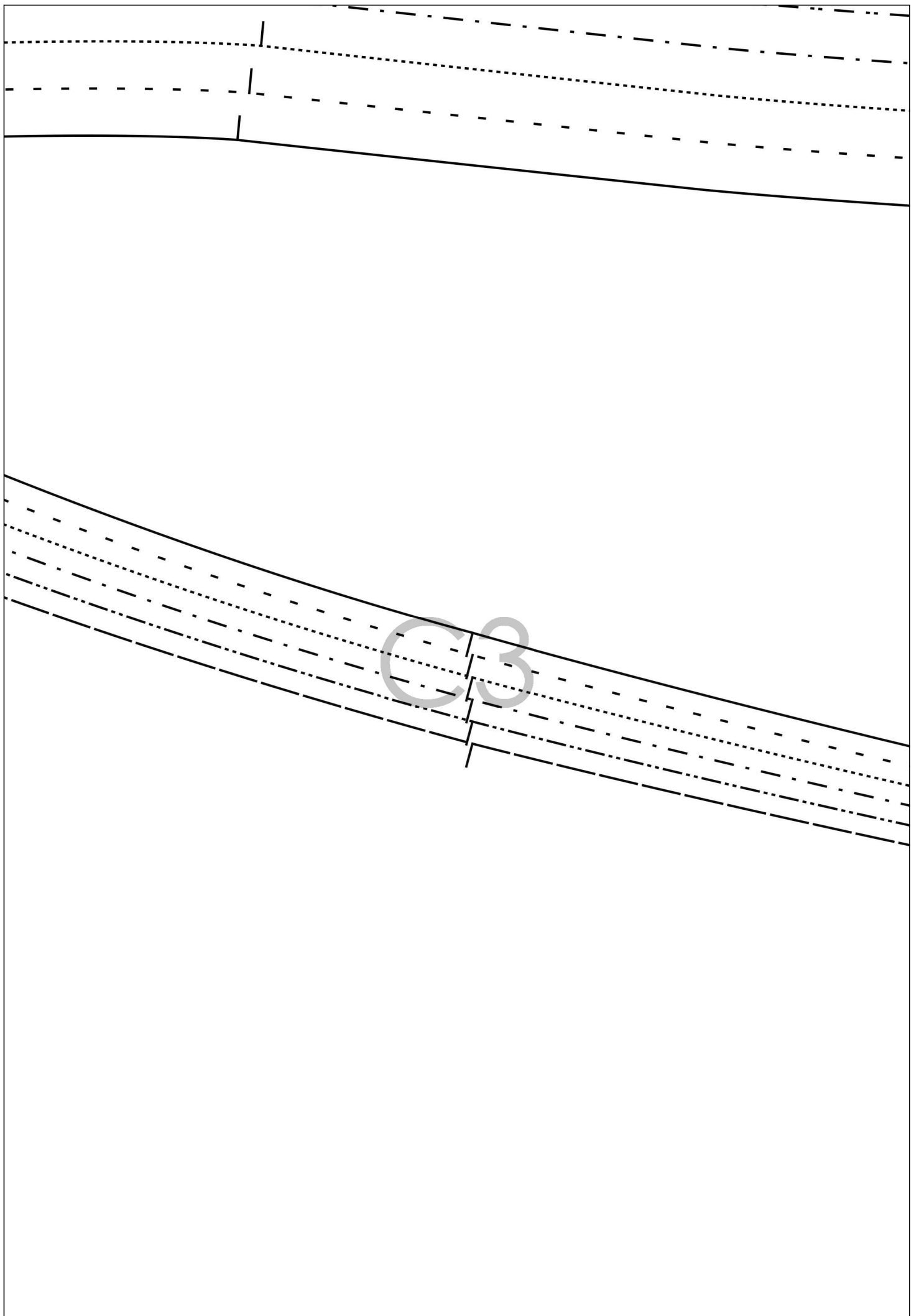

C4

Hemmers Itex
fabrics for your creativity

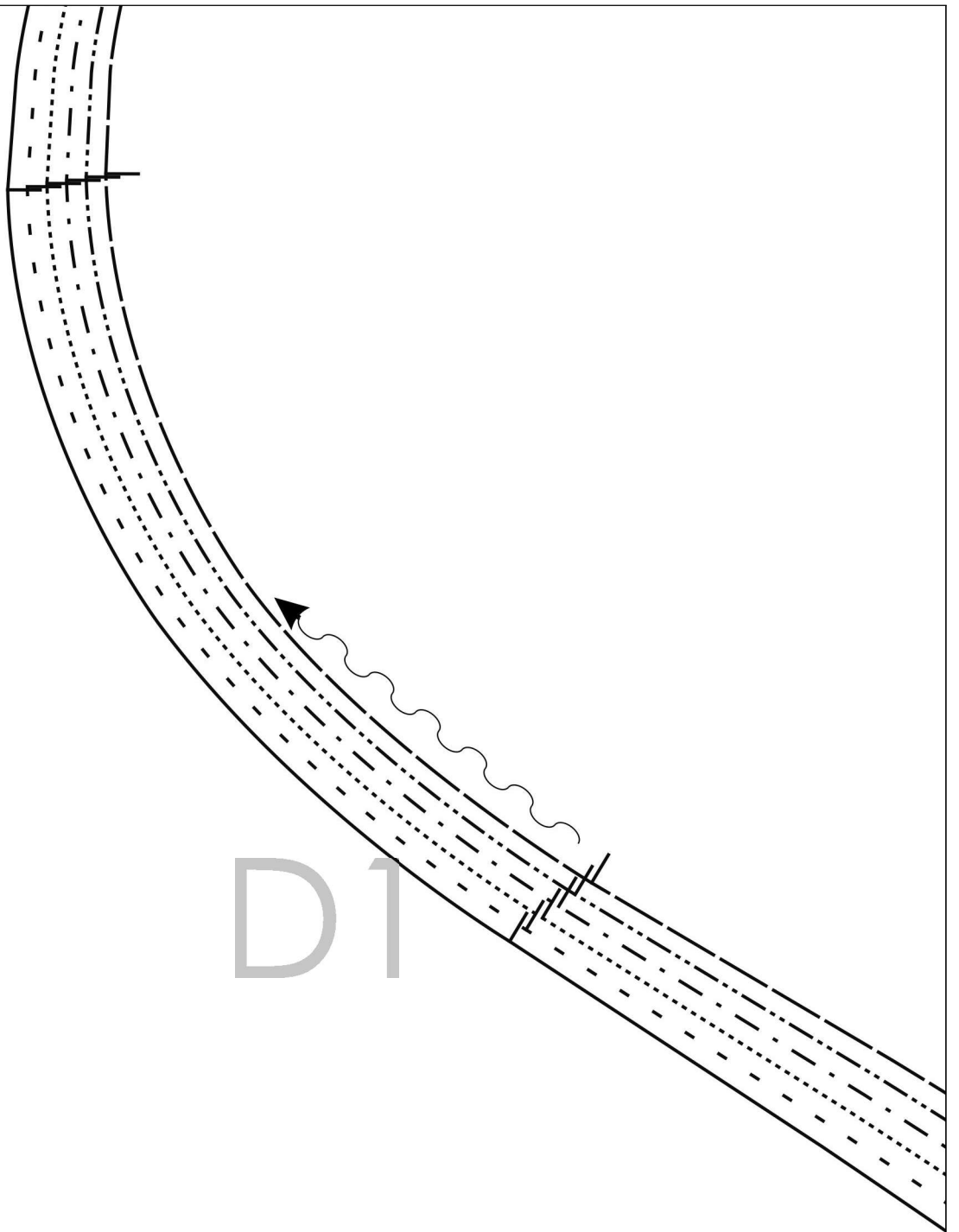

D1

Rollkragen Shirt mit
Ärmel 2
Puff sleeves turtle
Sleeve 2

D2

