

Eine Nahtzugabe von 0,8 cm ist bereits im Schnitt enthalten.

A seam allowance of 0,8 cm is already included in the pattern.

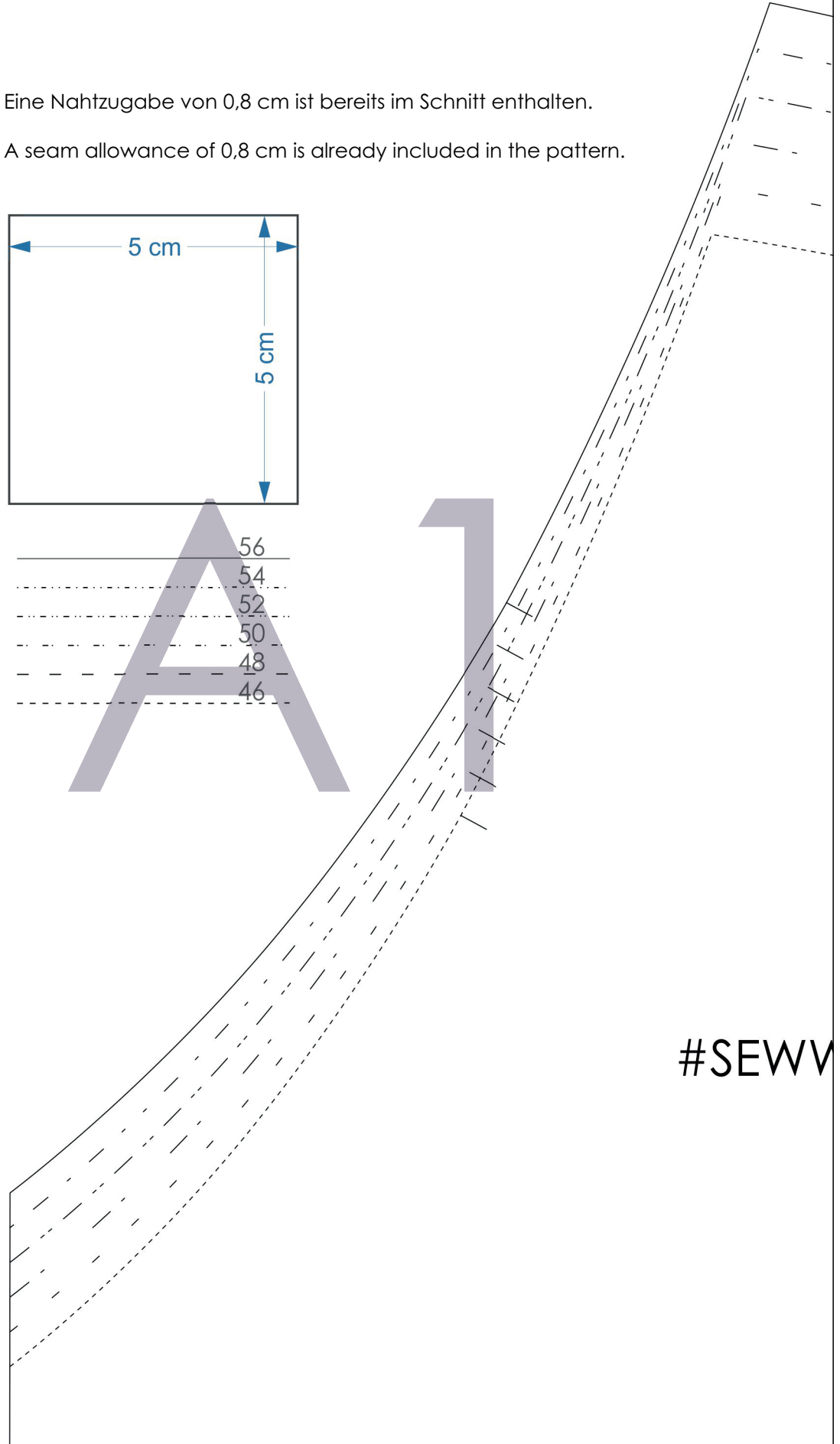

#SEWV

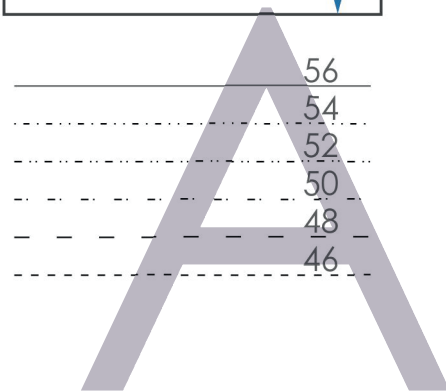
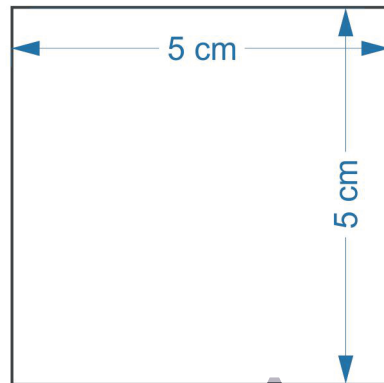
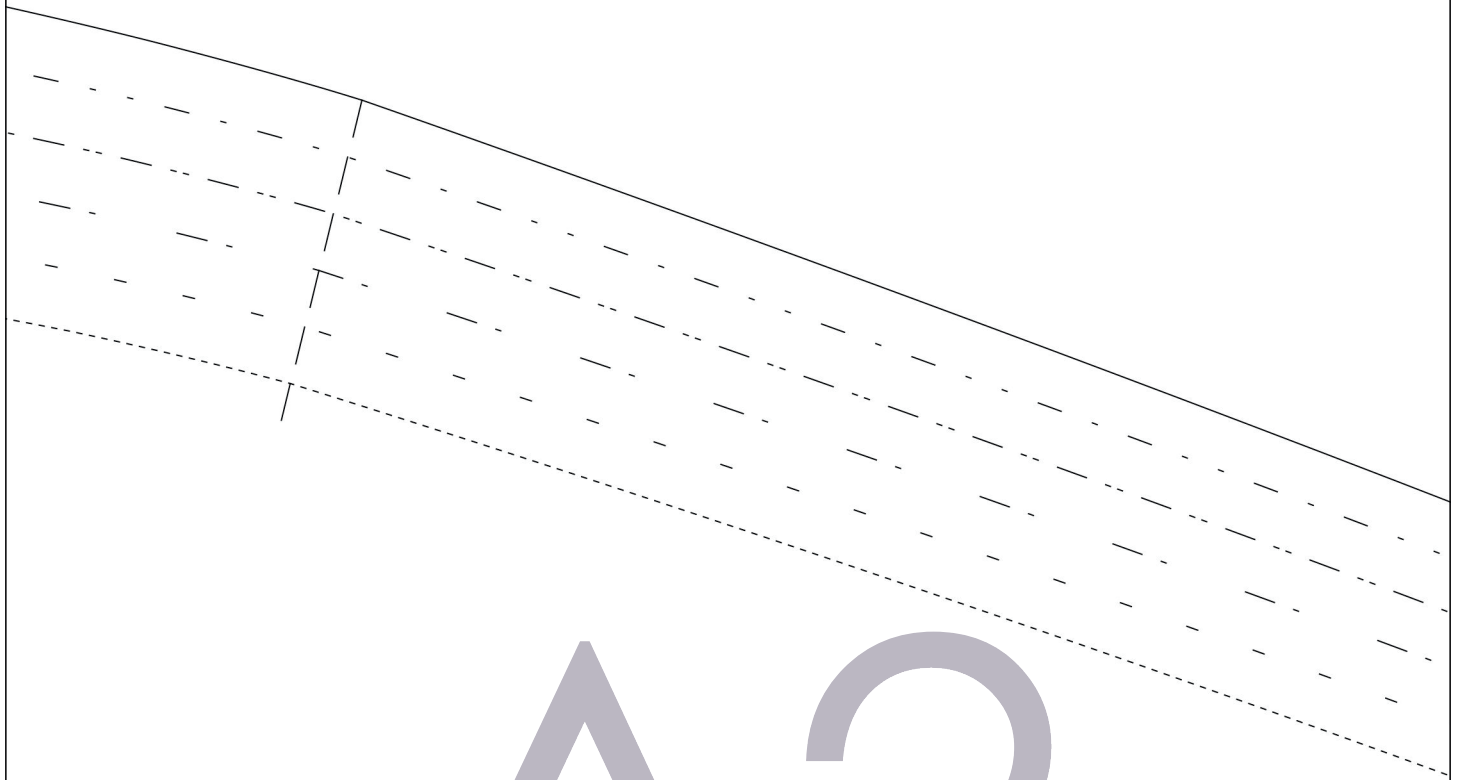

A2

WONDERFULLYDRESS

VORDERTEIL

FRONT

A3

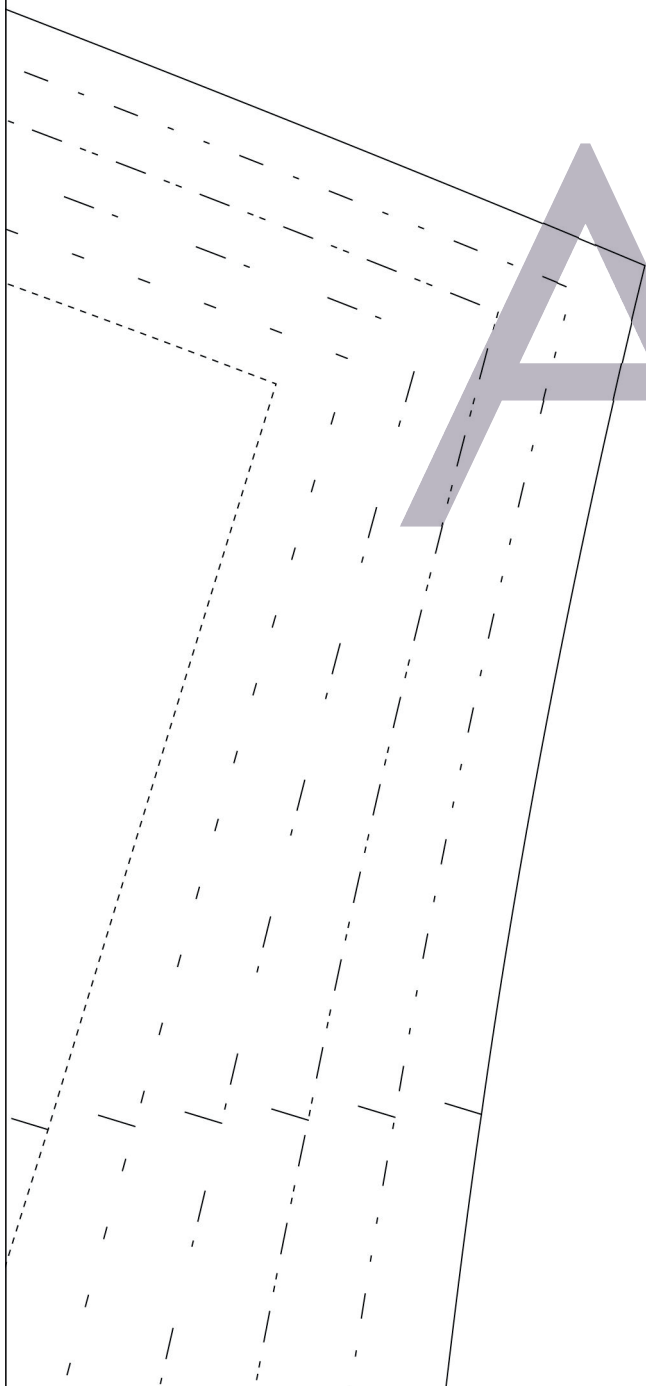

Stoffbruch / Fold

B1

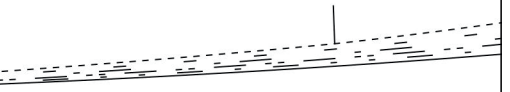

B2

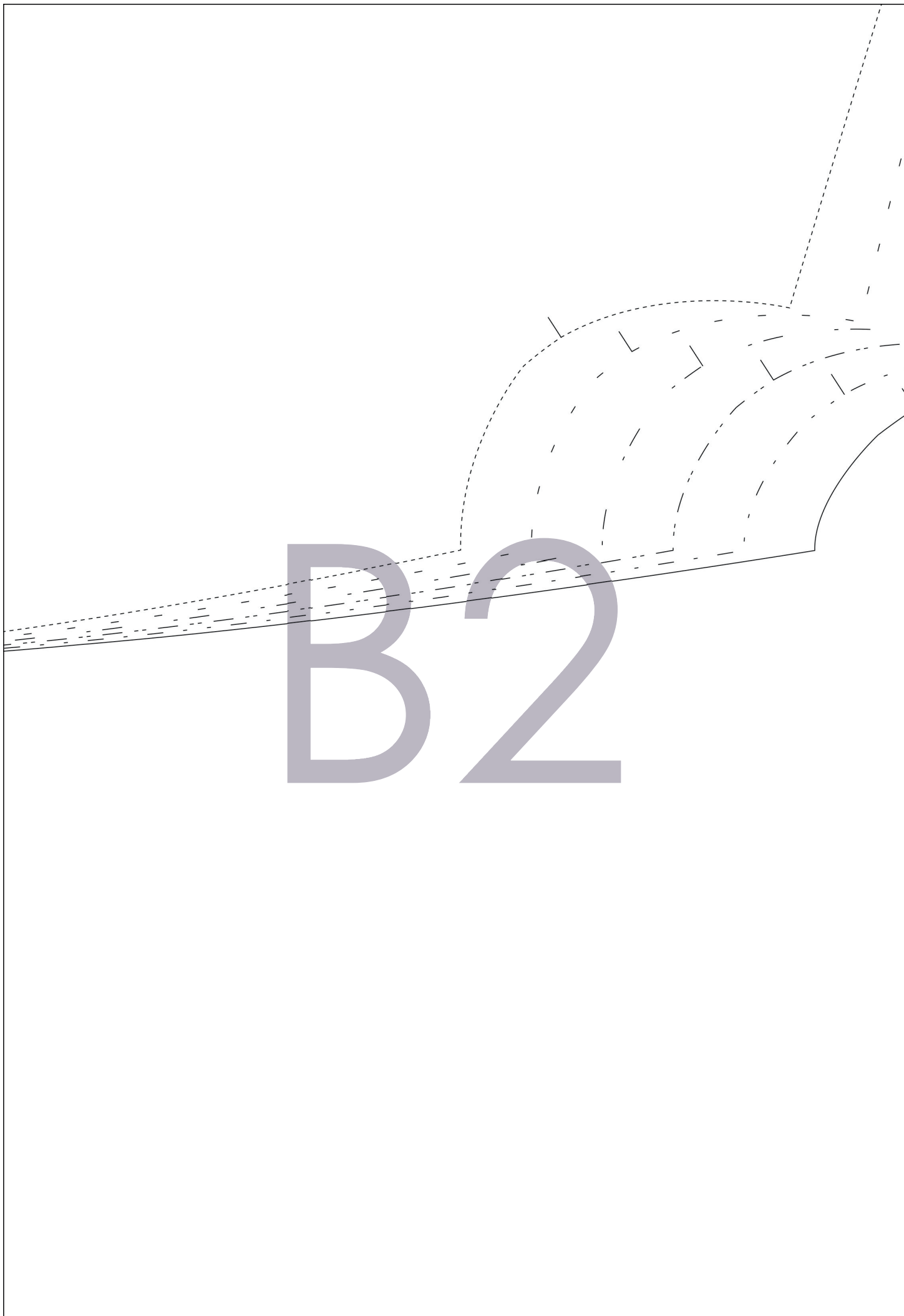

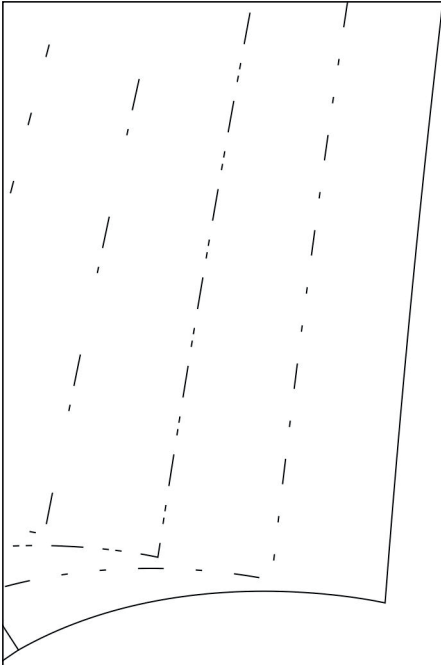

B3



C1

#SEWWONDER

VORDERE R

SKIRT F

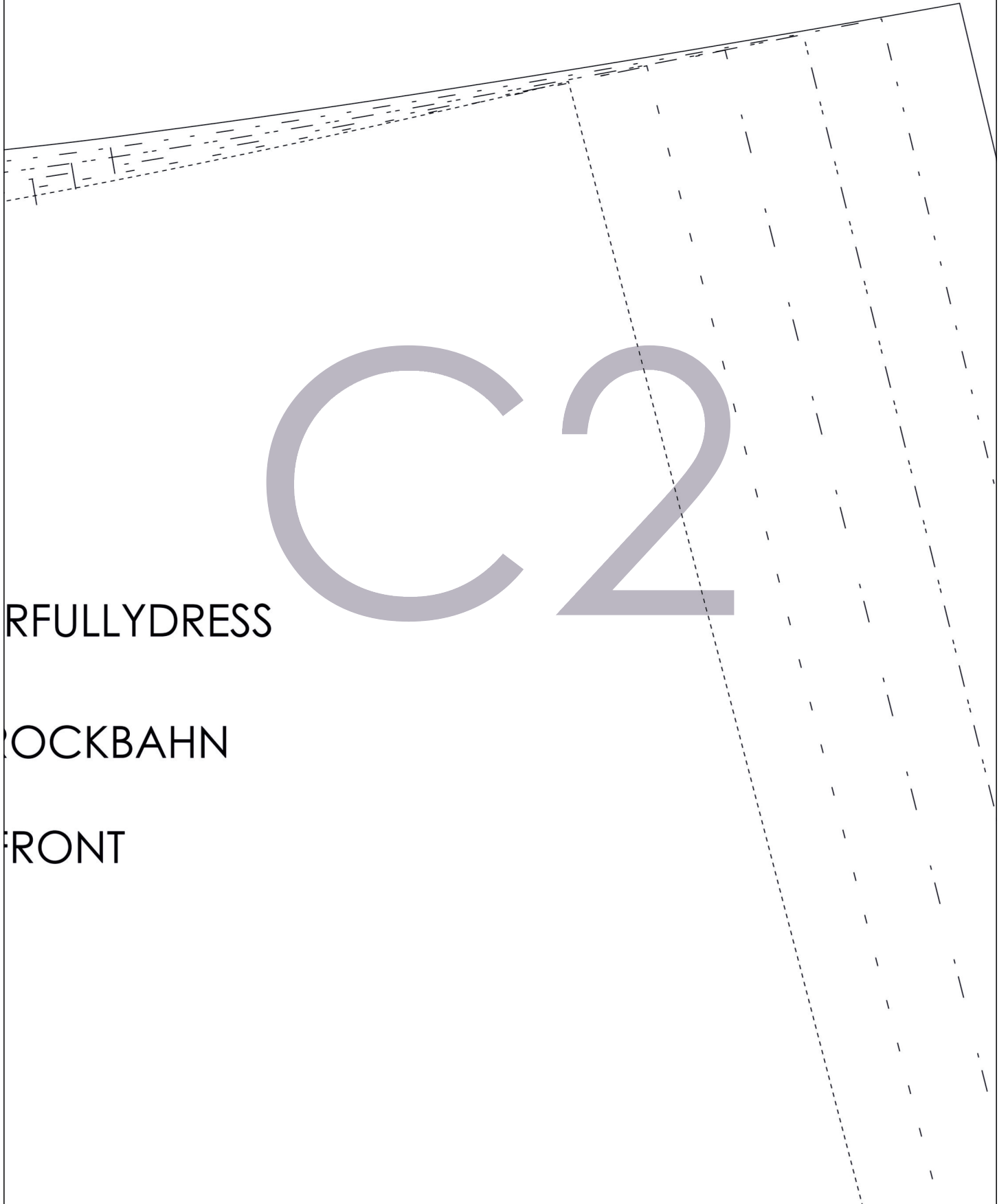

C2

FRONT FULLYDRESS

ROCKBAHN

FRONT



C3

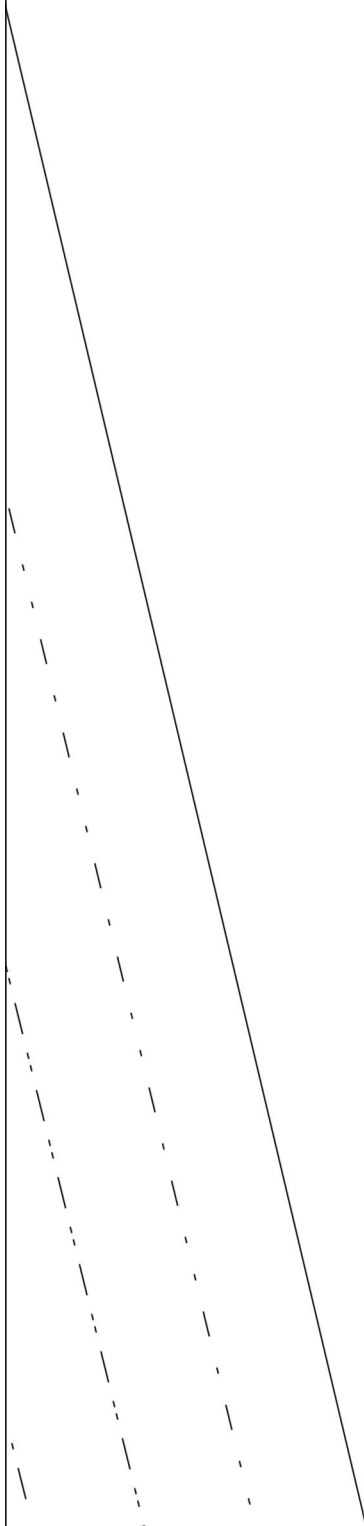

hoffbruch / Fold

D1

D2

D 3

E1

**Hemmers Itex**  
*fabrics for your creativity*

E2

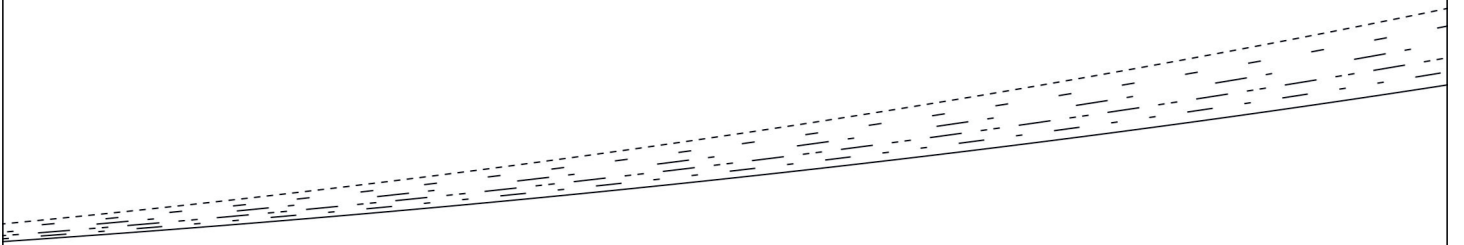

E3

F1

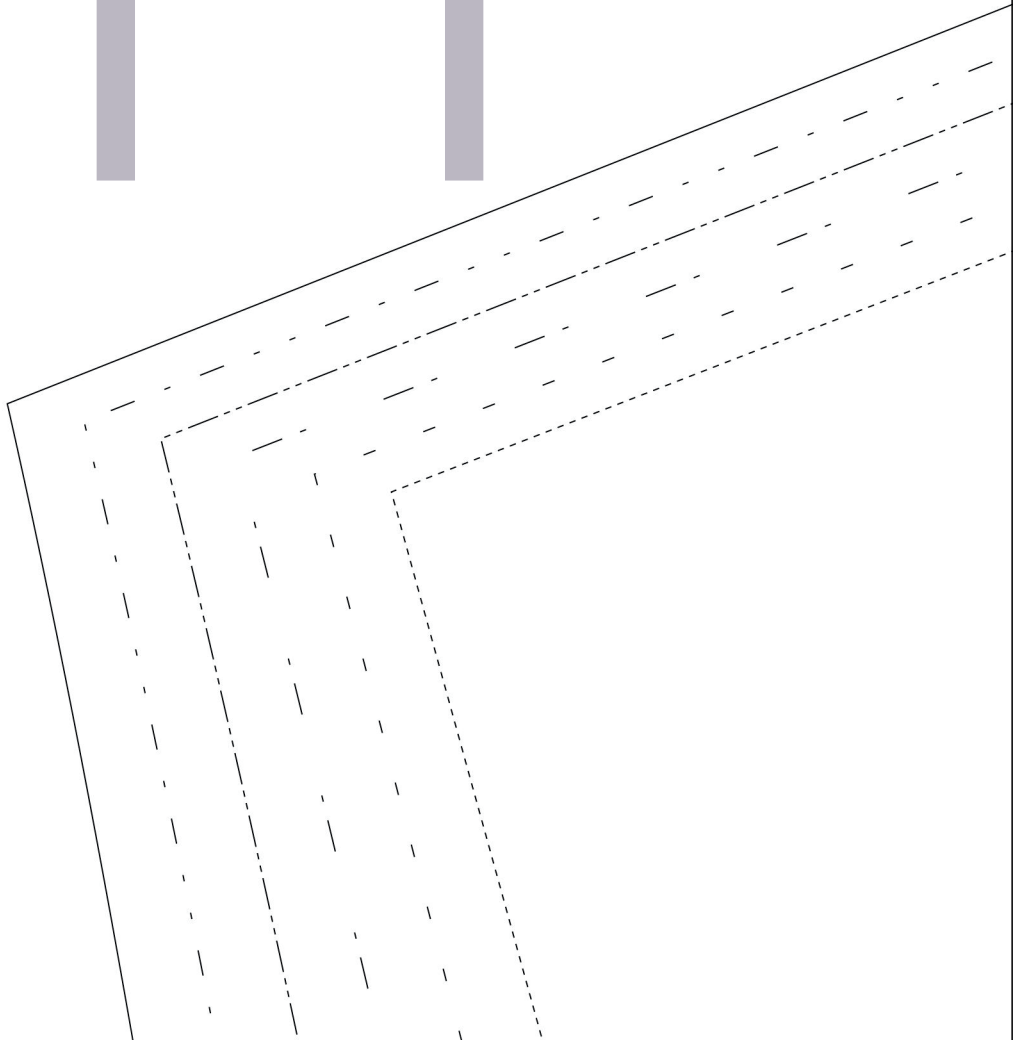



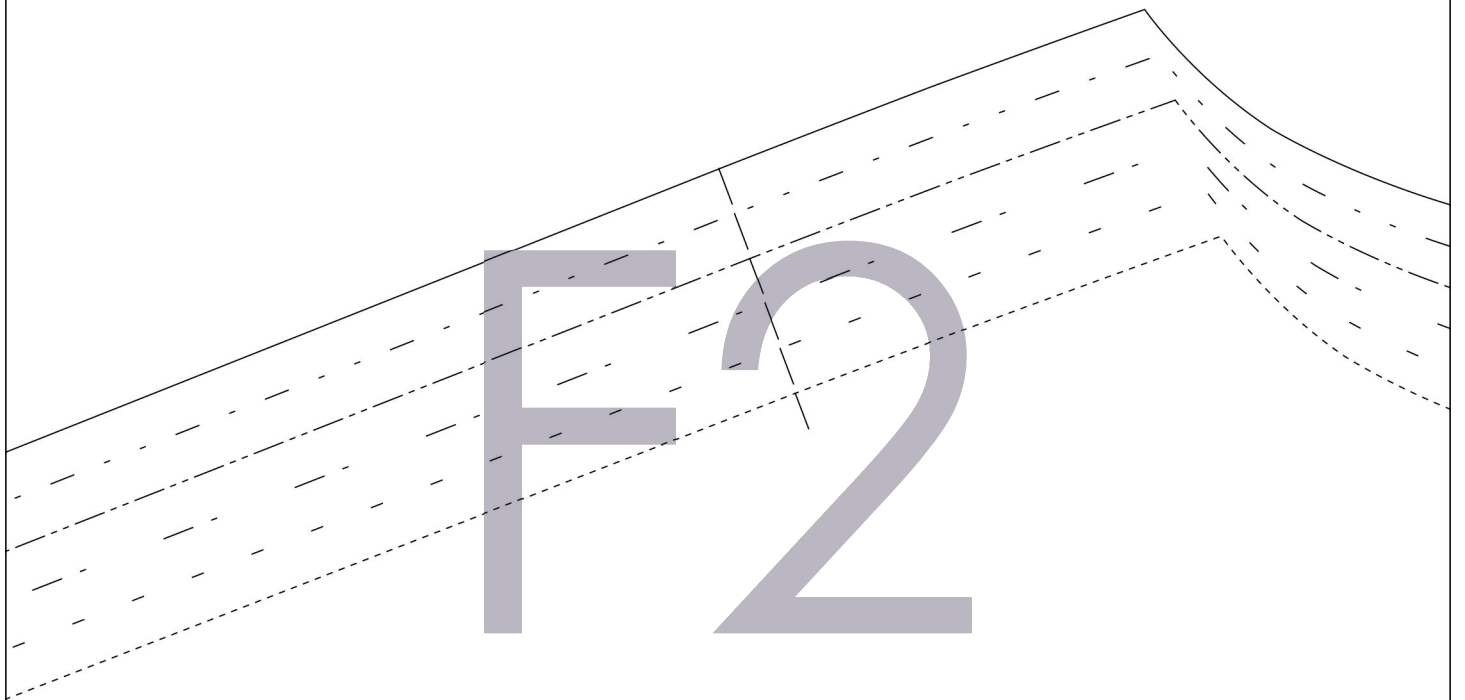

#SEWWONDERFULLYDRESS

RÜCKENTEIL

F3

Gg

BACK

G2

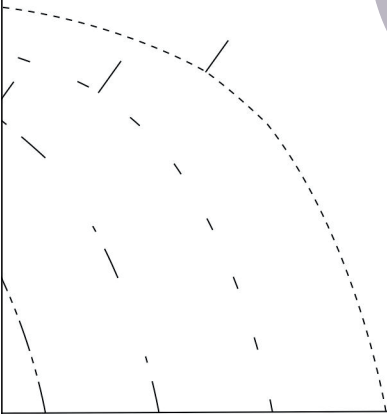

Stoffbruch / Fold

# G3

**Hemmers Itex**  
*fabrics for your creativity*

НН1

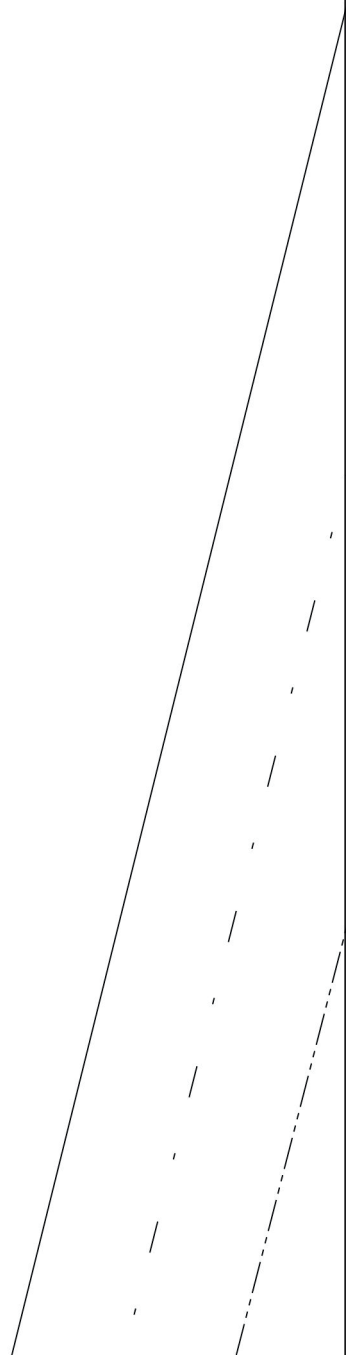



# H2

#SEWWONDERFUL

RÜCKWERTIGE R

SKIRT BAU

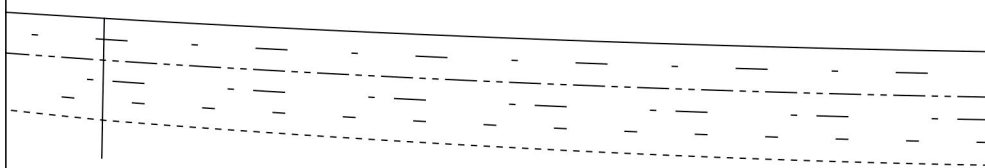

НЗ

JLLYDRESS

OCKBAHN

CK



11

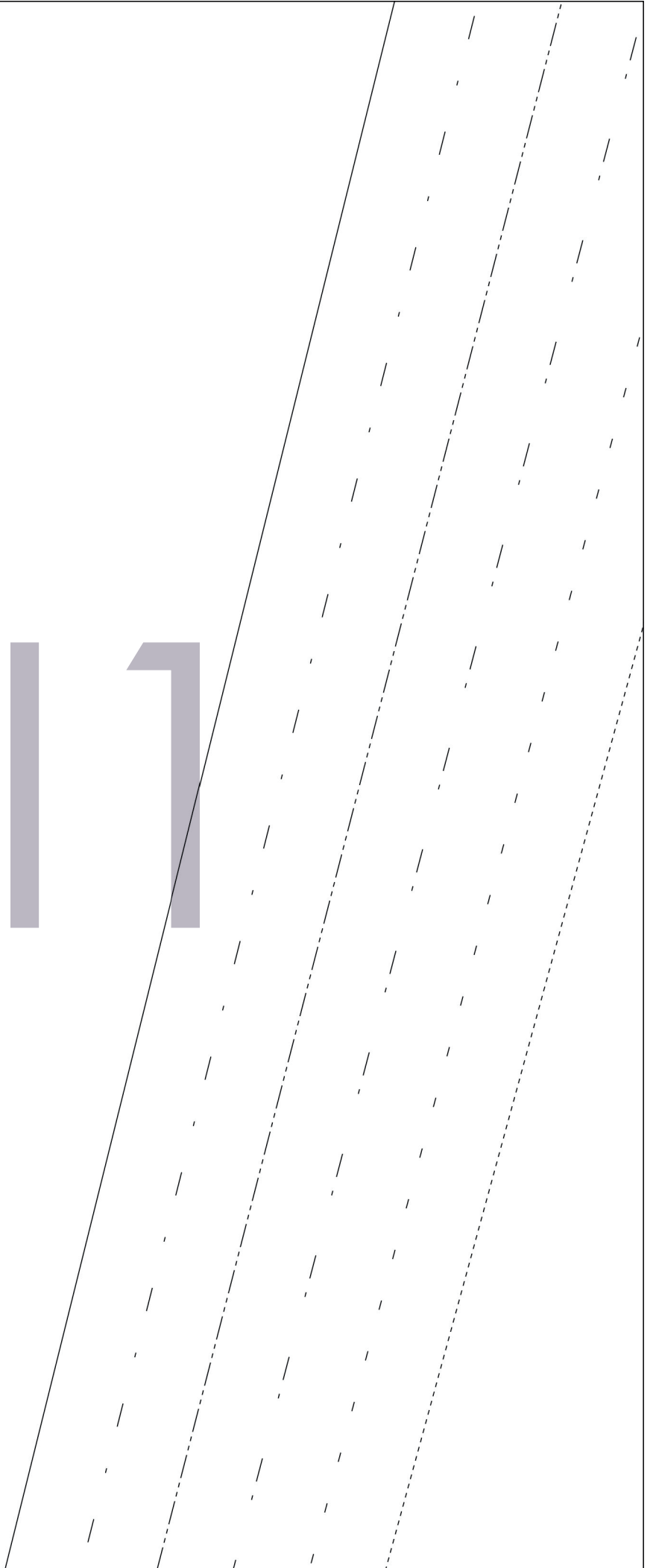



12

13

Stoffbruch / Fold

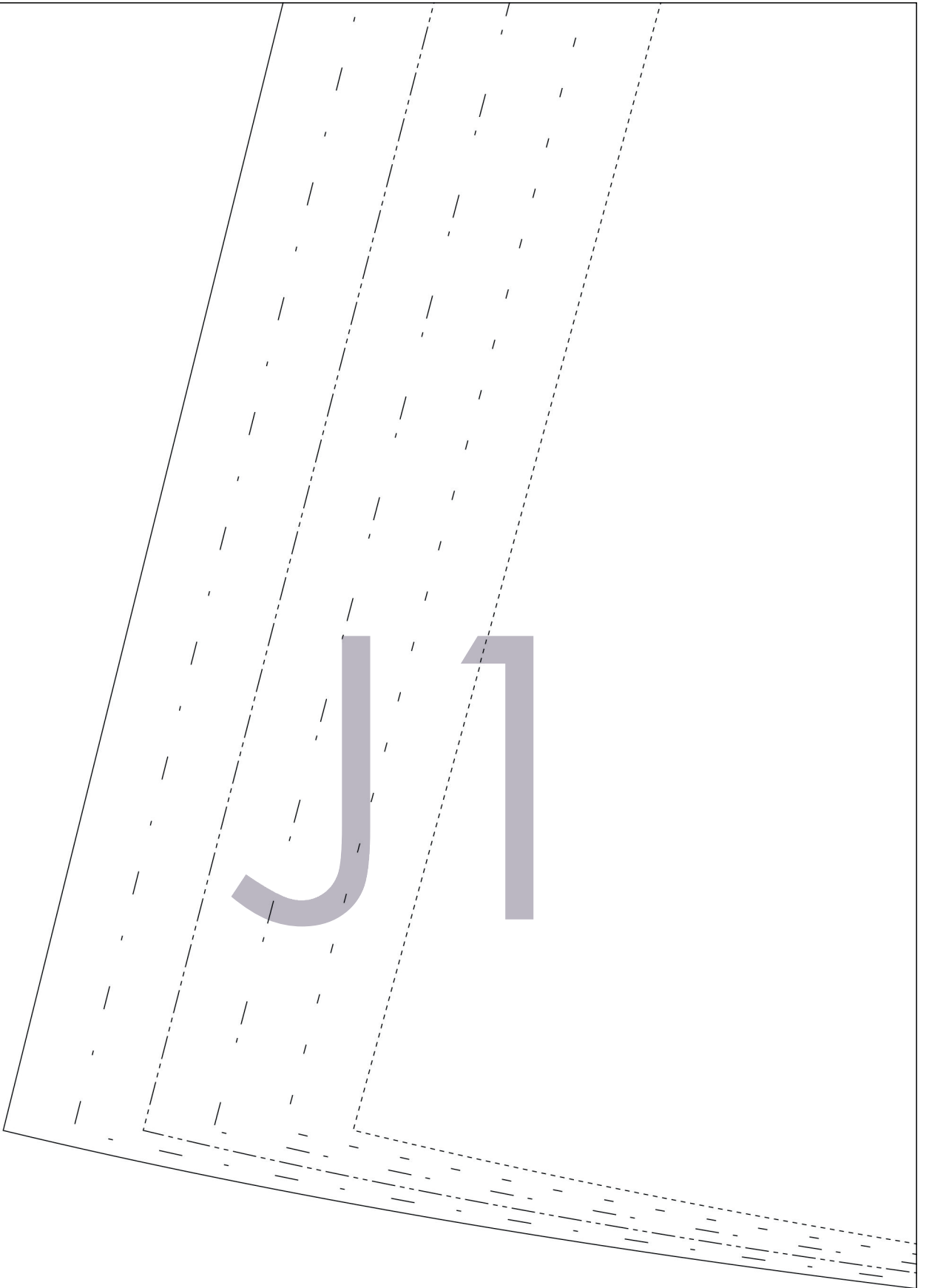

J2

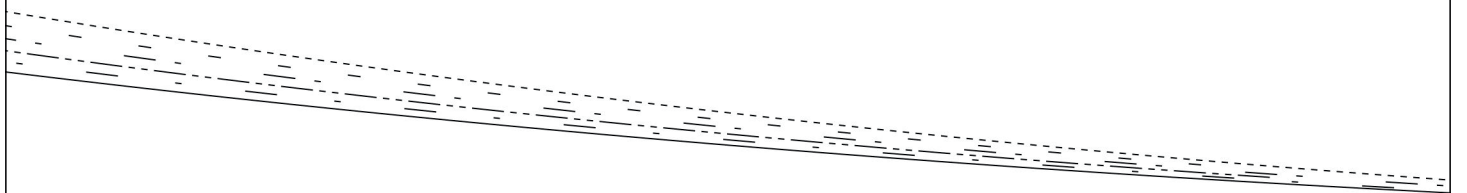

J3

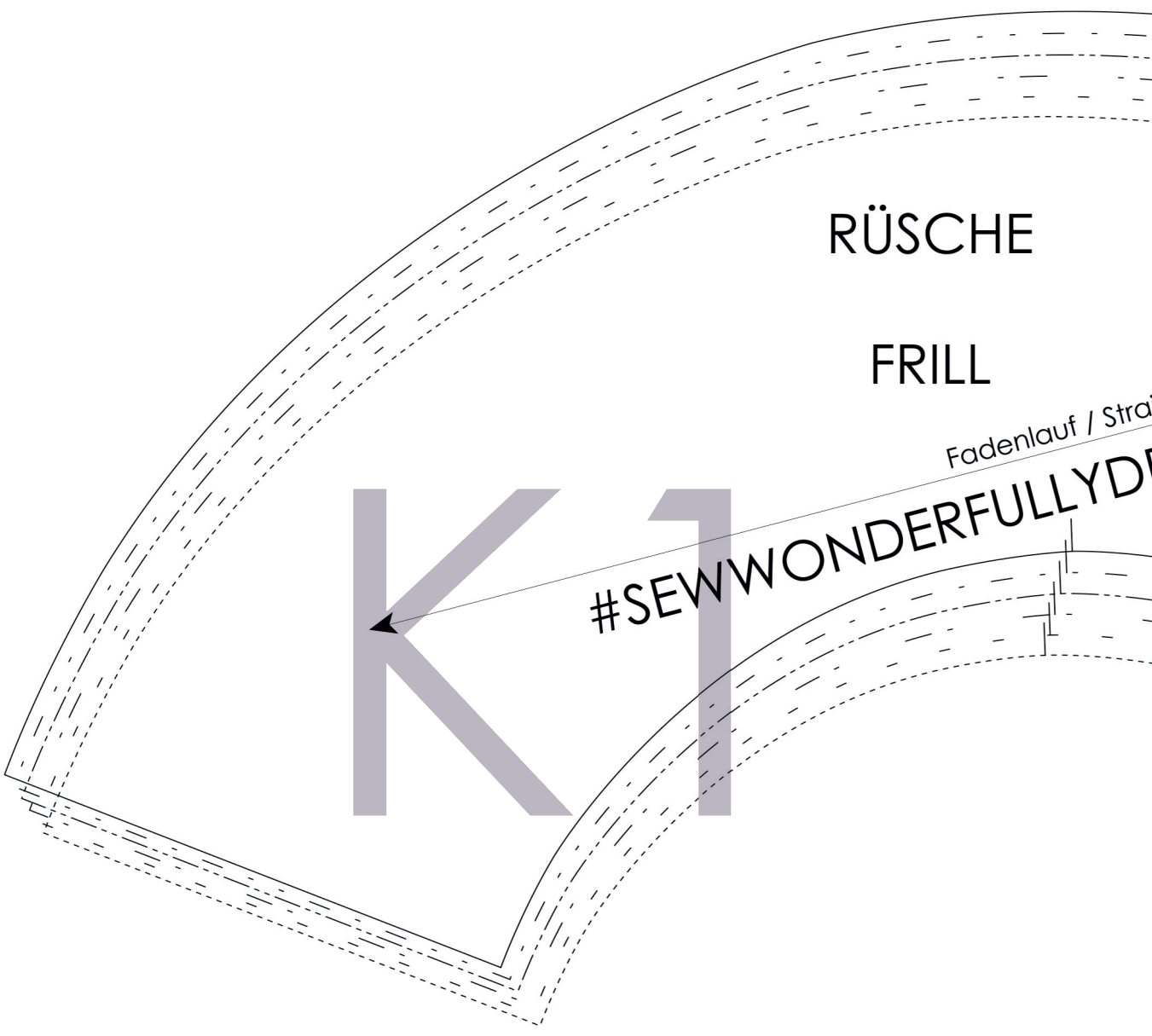

RÜSCHE

FRILL

Fadenlauf / Strai

#SEWWONDERFULLYDE

K1

ght grain  
RESS



K2





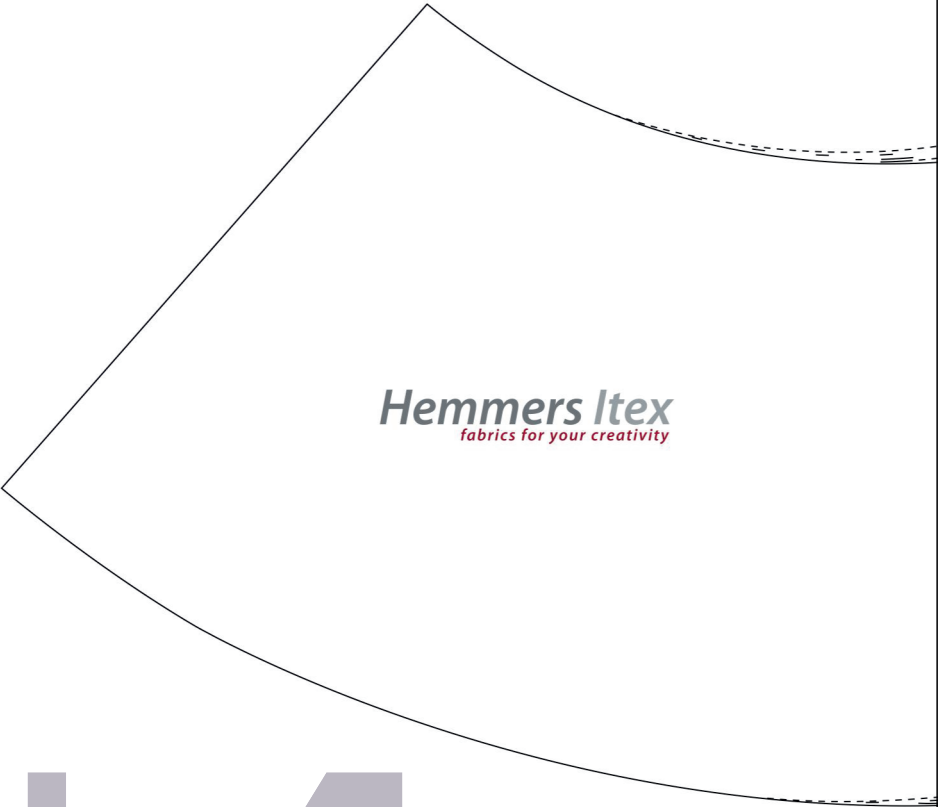

**Hemmers Itex**  
fabrics for your creativity

L1

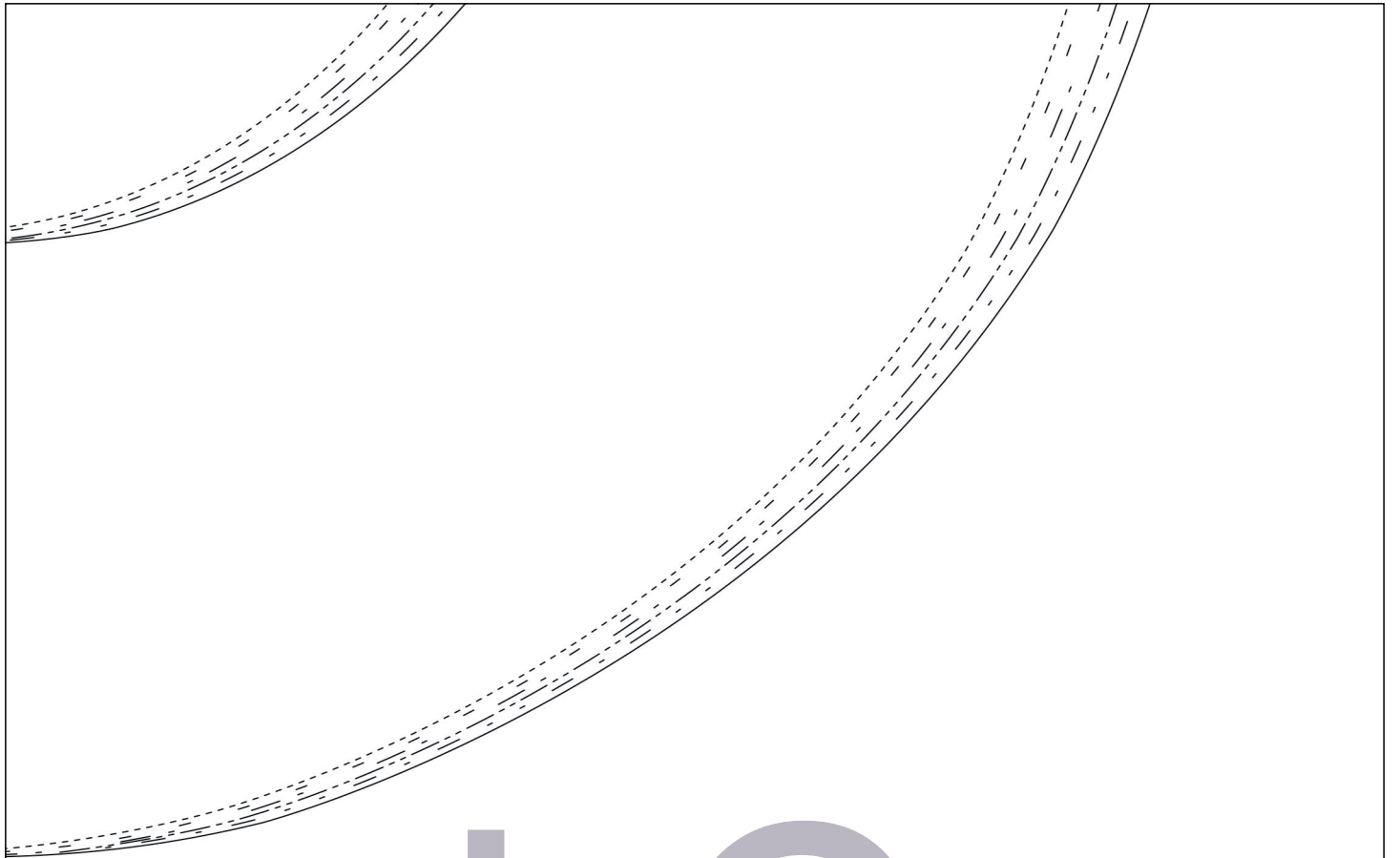

L2