

Der Schnitt enthält keine Nahtzug  
Seam allowance not included.

- 46 \_\_\_\_\_
- 44 - - - - -
- 42 - - - - -
- 40 - - - - -
- 38 - - - - -
- 36 \_\_\_\_\_

A2

abe.

A3

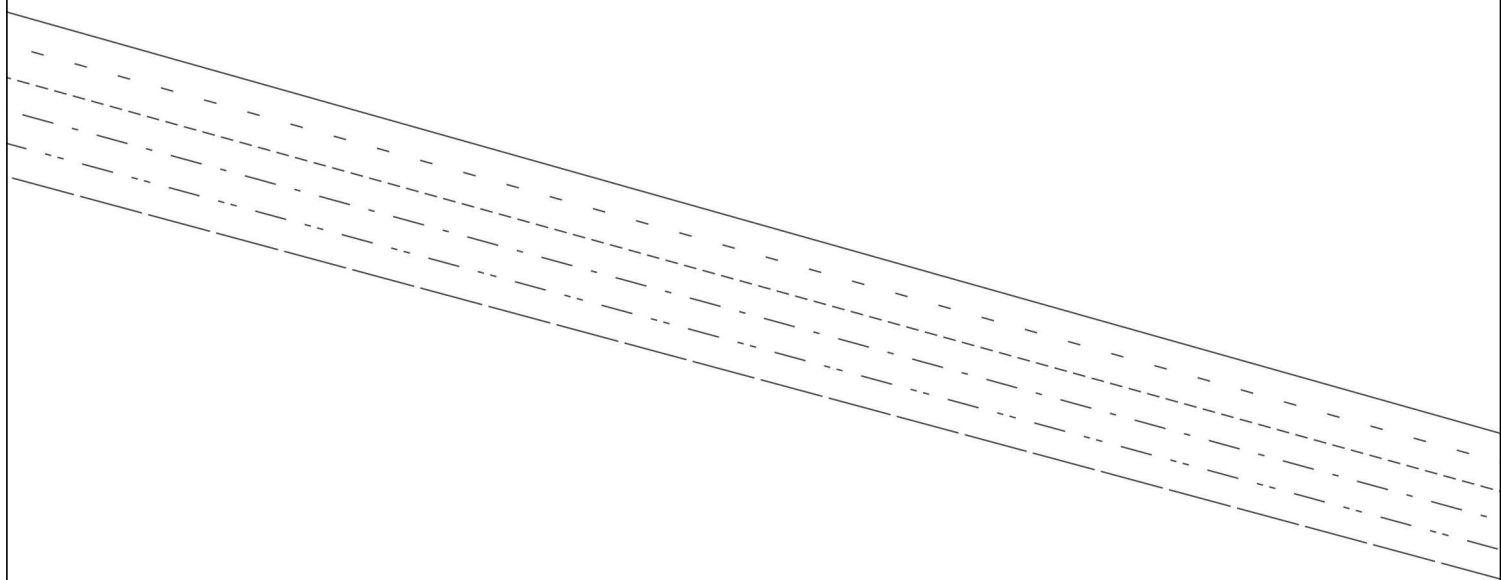

A4

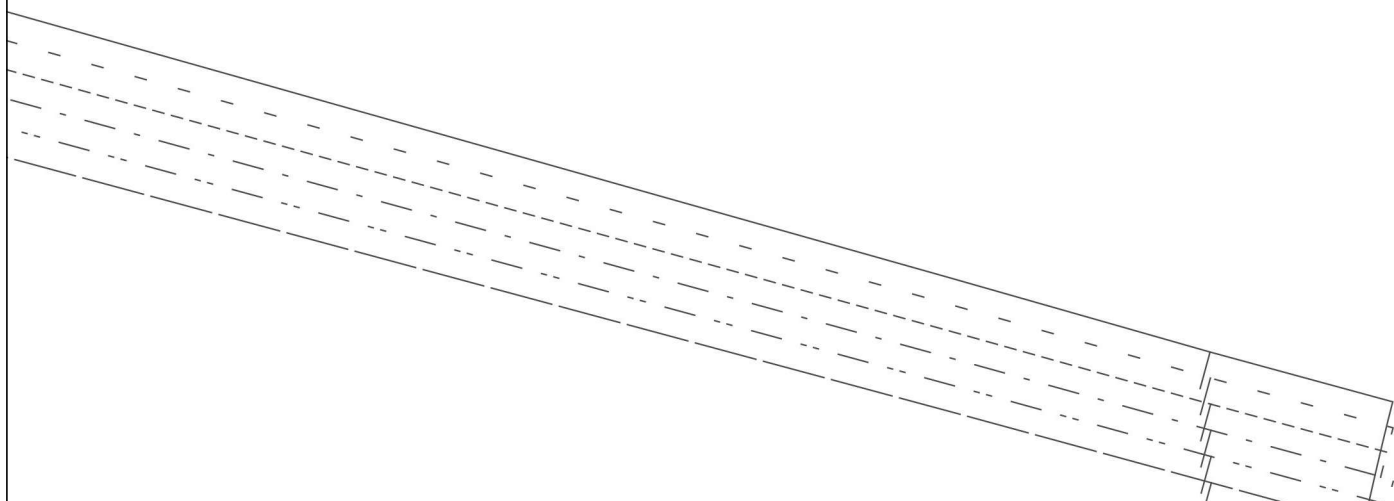

CARDIGAN

Vorderte

2 x

Front

2 x

B1

Fadenlauf/ Grainline

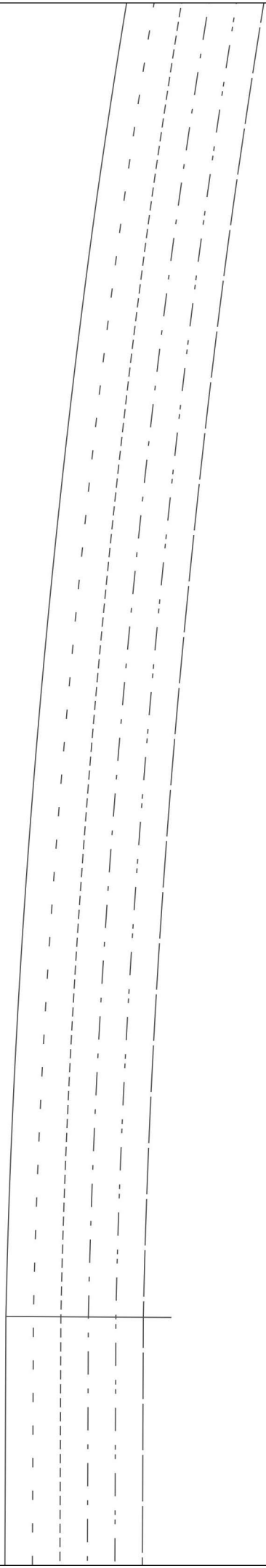

N CINDY  
eil 1A

1A

B2

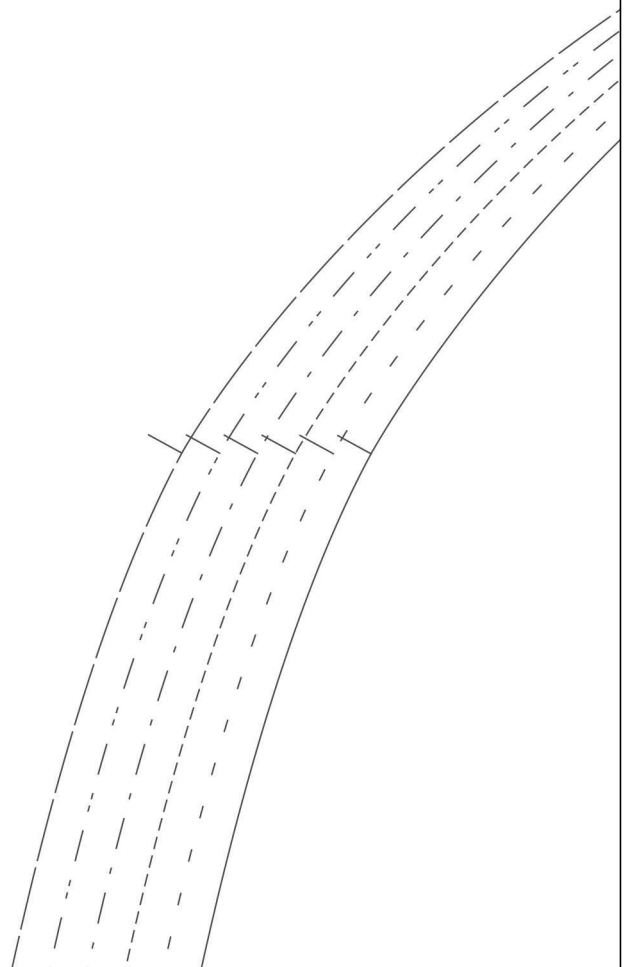

B3

Rückw. Besatz 1 x im  
Neck Facing 1 x on

Hemmers Itex  
fabrics for your creativity

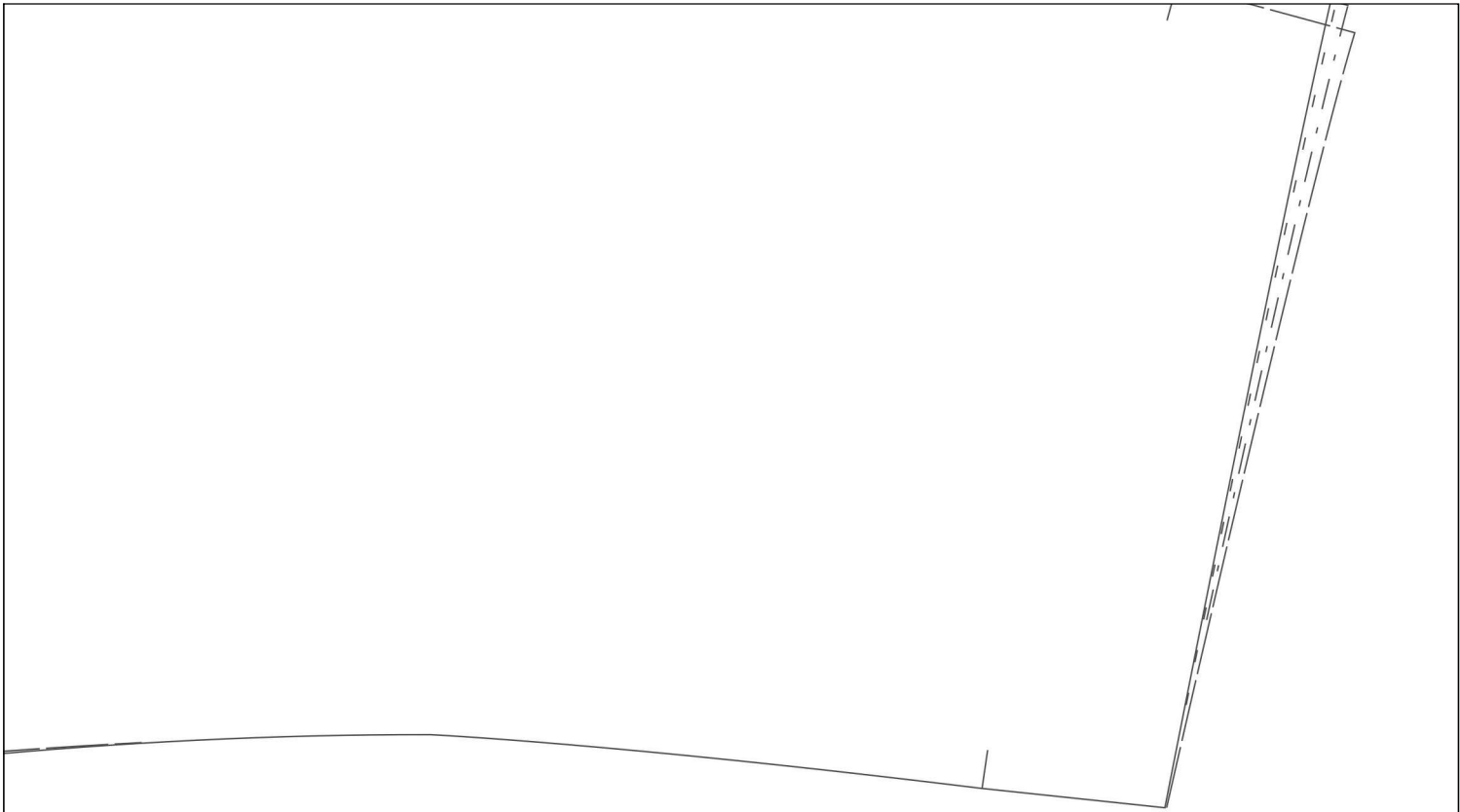

B4

Bruch  
fold  
Fold  
Stoffbruch

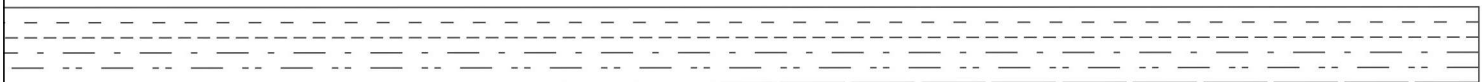



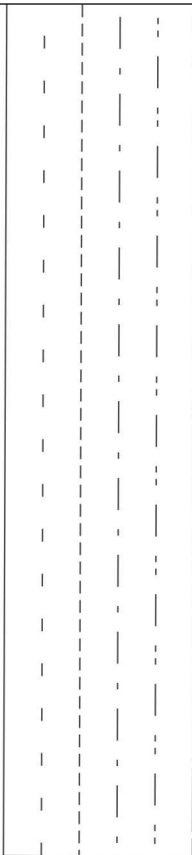

C1

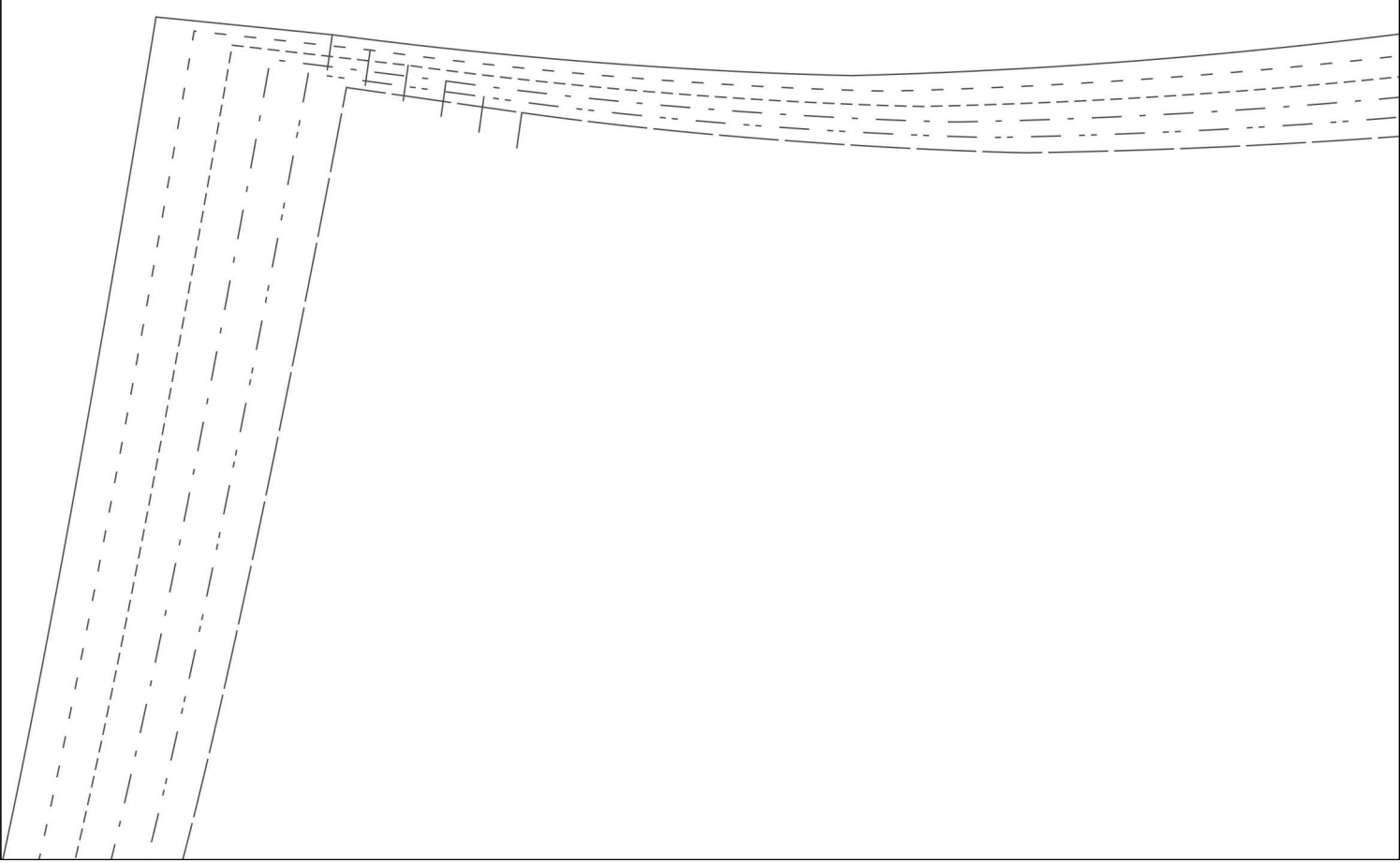

**Hemmers Itex**  
fabrics for your creativity

C2

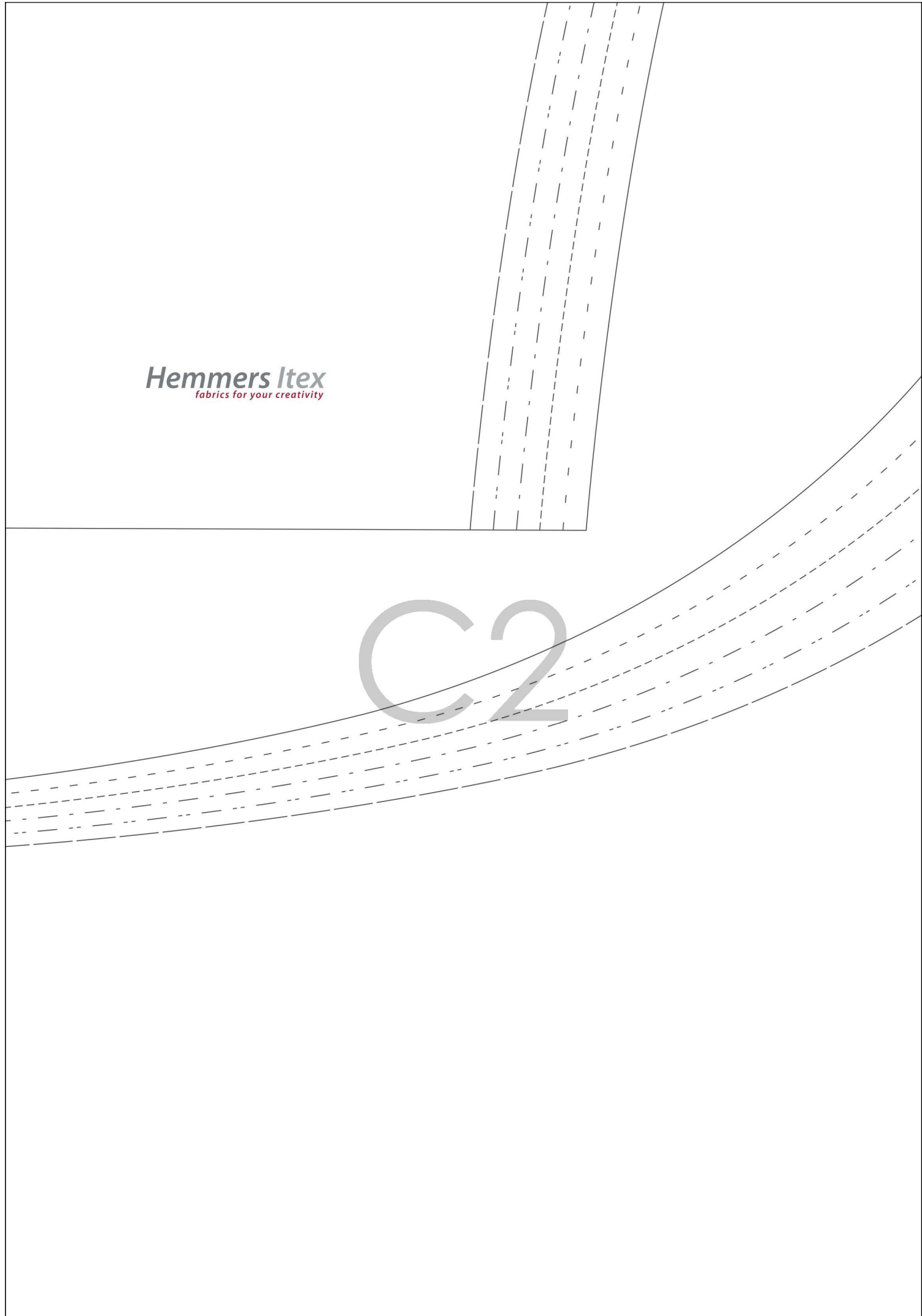

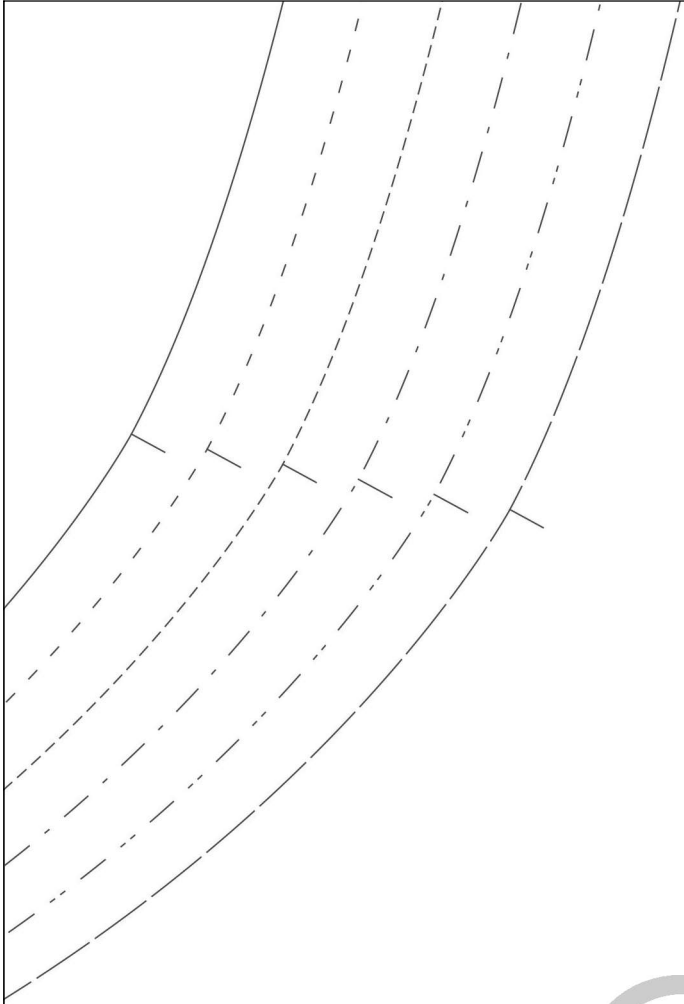

C3

# C4

Back 2A  
1 x on fold

CARDIGAN CINDY  
Rückenteil 2A  
1 x im Bruch

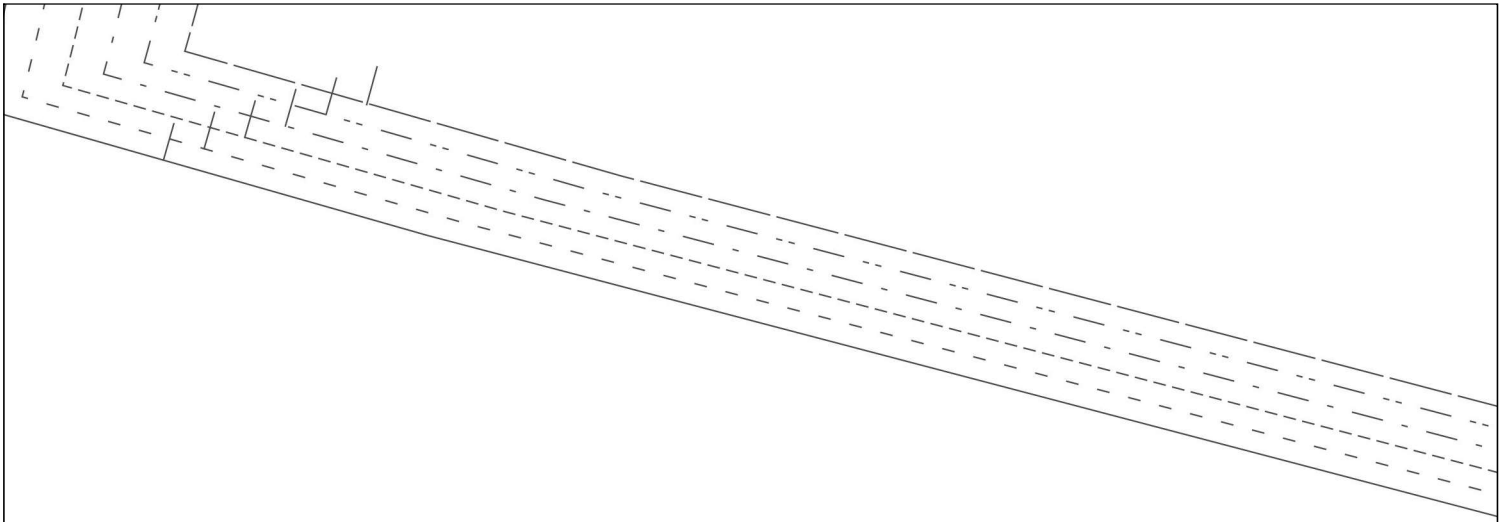

D1

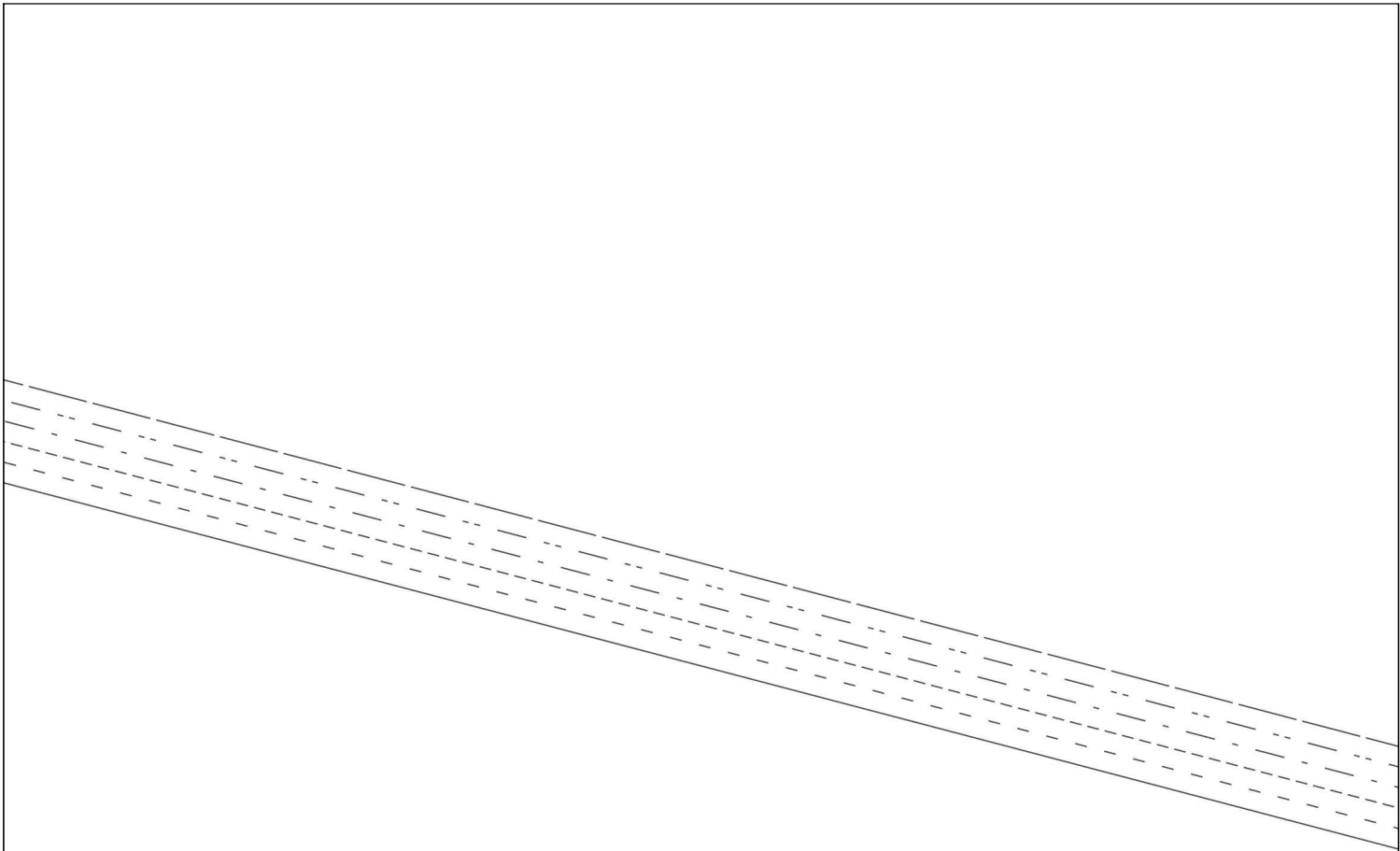

D2

DS

Stoffbruch / Fold

D4

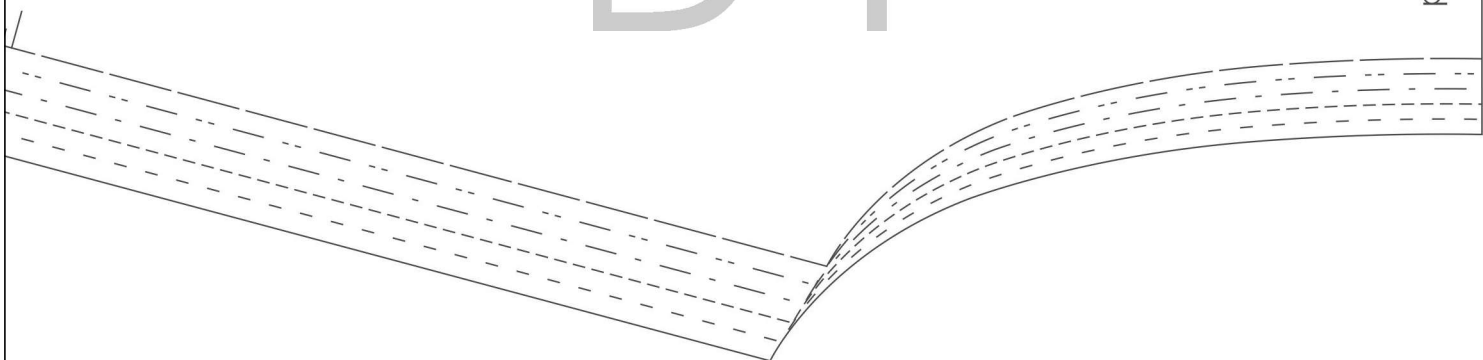





E1

E2

CARDIGAN CINDY  
Vorderteil 1B  
2 x

Front 1B  
2 x

E3

Fadenlauf/ Grainline

F1

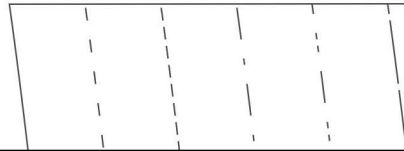

F2

**Hemmers Itex**  
*fabrics for your creativity*



F3

Vord. Besatz 2 x  
Front facing 2 x

G1

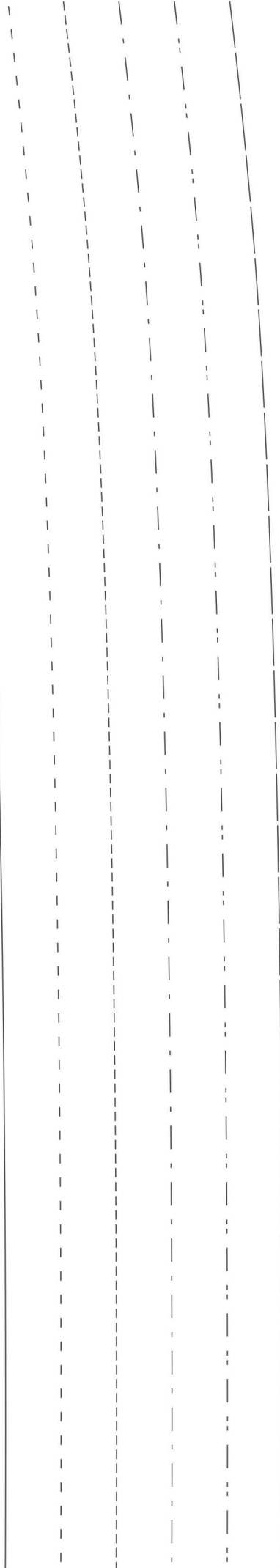

CARDIGAN CINDY  
Rückenteil 2B  
1 x im Bruch

Back 2B  
1 x on fold



G3



# H2

**Hemmers Itex**  
*fabrics for your creativity*

H3